



ROHDE & SCHWARZ

Test and Measurement
Division

Quick Start Manual

Handheld Spectrum Analyzer

R&S[®] FSH

1145.5850.03

1145.5850.13

1145.5850.23

1145.5850.06

1145.5850.26

1145.5850.18

Dear Customer,

R&S® is a registered trademark of Rohde & Schwarz GmbH & Co. KG.
Trade names are trademarks of the owners.

1145.5980.12-12-

2

Safety Instructions

This unit has been designed and tested in accordance with the EC Certificate of Conformity and has left the manufacturer's plant in a condition fully complying with safety standards.

To maintain this condition and to ensure safe operation, the user must observe all instructions and warnings given in this operating manual.

Safety-related symbols used on equipment and documentation from R&S:



Observe operating instructions



PE terminal

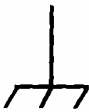

Ground terminal



Danger!
Shock hazard



Warning!
Hot surfaces



Ground



Attention!
Electrostatic sensitive devices require special care

Safety Instructions

1. The unit may be used only in the operating conditions and positions specified by the manufacturer. The R&S FSH is protected against dripping water and dust (IP degree 51). Unless otherwise agreed, the following applies : pollution severity 2, overvoltage category 2, altitude max. 2000 m powered from AC power supply, altitude max. 3000 m powered from battery.
The unit may be operated only from supply networks fused with max. 16 A.
Unless specified otherwise in the data sheet, a tolerance of $\pm 10\%$ shall apply to the nominal voltage and of $\pm 5\%$ to the nominal frequency.
2. For measurements in circuits with voltages $V_{\text{rms}} > 30 \text{ V}$, suitable measures should be taken to avoid any hazards (using, for example, appropriate measuring equipment, fusing, current limiting, electrical separation, insulation).
3. For permanently installed units without built-in fuses, circuit breakers or similar protective devices, the supply circuit must be fused such as to provide suitable protection for the users and equipment.
4. Prior to switching on the unit, it must be ensured that the nominal voltage set on the unit matches the nominal voltage of the AC supply network.
If a different voltage is to be set, the power fuse of the unit may have to be changed accordingly.
5. If the unit has no power switch for disconnection from the AC supply, the plug of the connecting cable is regarded as the disconnecting device. In such cases it must be ensured that the power plug is easily reachable and accessible at all times (length of connecting cable approx. 2 m). Functional or electronic switches are not suitable for providing disconnection from the AC supply.
If units without power switches are integrated in racks or systems, a disconnecting device must be provided at system level.
6. Applicable local or national safety regulations and rules for the prevention of accidents must be observed in all work performed.
Prior to performing any work on the unit or opening the unit, the latter must be disconnected from the supply network.
Any adjustments, replacements of parts, maintenance or repair may be carried out only by authorized R&S technical personnel.
Only original parts may be used for replacing parts relevant to safety (eg power switches, power transformers, fuses). A safety test must be performed after each replacement of parts relevant to safety.
(visual inspection, PE conductor test, insulation-resistance, leakage-current measurement, functional test).
7. Ensure that the connections with information technology equipment comply with IEC950 / EN60950.
8. NiMH batteries must not be exposed to high temperatures or fire.
Keep batteries away from children.
If the battery is replaced improperly, there is danger of explosion. Only replace the battery by R&S type (see spare part list).
NiMH batteries are suitable for environmentally-friendly disposal or specialized recycling. Dispose them into appropriate containers, only.
Do not short-circuit the battery.
9. Equipment returned or sent in for repair must be packed in the original packing or in packing with electrostatic and mechanical protection.
10. Electrostatics via the connectors may damage the equipment. For the safe handling and operation of the equipment, appropriate measures against electrostatics should be implemented.
11. The outside of the instrument is suitably cleaned using a soft, lint-free dustcloth. Never use solvents such as thinners, acetone and similar things, as they may damage the front panel labeling or plastic parts.
12. Any additional safety instructions given in this manual are also to be observed.

Certificate of quality

Dear Customer,

You have decided to buy a Rohde & Schwarz product.

You are thus assured of receiving a product that is manufactured using the most modern methods available. This product was developed, manufactured and tested in compliance with our quality management system standards. The Rohde & Schwarz quality management system is certified according to ISO 9001.

Certified Quality System

ISO 9001

DQS REG. NO 1954-04



ROHDE & SCHWARZ
EC Certificate of Conformity



Certificate No.: 2002-41

This is to certify that:

Equipment type	Stock No.	Designation
FSH3	1145.5850.03/.13/.23	Handheld Spectrum Analyzer
FSH6	1145.5850.06/.26	
FSH18	1145.5850.18	
FSH-Z1	1155.4505.02	Average Power Sensor
FSH-Z2	1145.5767.02	VSWR Bridge and Power Driver
FSH-Z3	1300.7756.02	VSWR Bridge
FSH-Z14	1120.6001.02	Directional Power Sensor
FSH-Z18	1165.1909.02	Average Power Sensor
FSH-Z21	1300.7579.02	12V Car Adapter
FSH-Z32	1145.5796.02	Spare Batterie Pack
FSH-Z33	1145.5809.02	Spare Power Supply
FSH-Z34	1145.5815.02	Optical RS232 Interface Cable
FSH-Z37	1300.7733.02	Optical USB Interface Cable
FSH-Z44	1165.2305.02	Directional Power Sensor

complies with the provisions of the Directive of the Council of the European Union on the approximation of the laws of the Member States

- relating to electrical equipment for use within defined voltage limits
(73/23/EEC revised by 93/68/EEC)
- relating to electromagnetic compatibility
(89/336/EEC revised by 91/263/EEC, 92/31/EEC, 93/68/EEC)

Conformity is proven by compliance with the following standards:

EN61010-1 : 2001
EN55011 : 1998 + A1 : 1999, Klasse B
EN61326 : 1997 + A1 : 1998 + A2 : 2001 + A3 : 2003

For the assessment of electromagnetic compatibility, the limits of radio interference for Class B equipment as well as the immunity to interference for operation in industry have been used as a basis.

Affixing the EC conformity mark as from 2002

ROHDE & SCHWARZ GmbH & Co. KG
Mühldorfstr. 15, D-81671 München

Munich, 2006-11-14

Central Quality Management MF-QZ / Radde

Support Center

Should you have any technical questions concerning this Rohde & Schwarz product, please contact the hotline of Rohde & Schwarz Vertriebs-GmbH, Support Center.

Our hotline team will answer your questions and find solutions to your problems.

You can reach the hotline Monday through Friday from 8:00 until 17:00 CET.

If you need assistance outside office hours, please leave a message or send us a fax or e-mail. We will contact you as soon as possible.



If you wish to receive the latest news about and updates for a specific instrument, please send us a short e-mail indicating the instrument. We will then send you up-to-date information on a regular basis.

Support Center:

Telephone: +49 180 512 42 42

Fax: + 49 89 41 29 - 137 77

e-mail: CustomerSupport@rsd.rohde-schwarz.com

USA Customer Support Center:

Telephone: 1-888-837-8772 (1-888-Test-RSA)

E-mail: info@rsa.rohde-schwarz.com

1 Putting into Operation

Front view

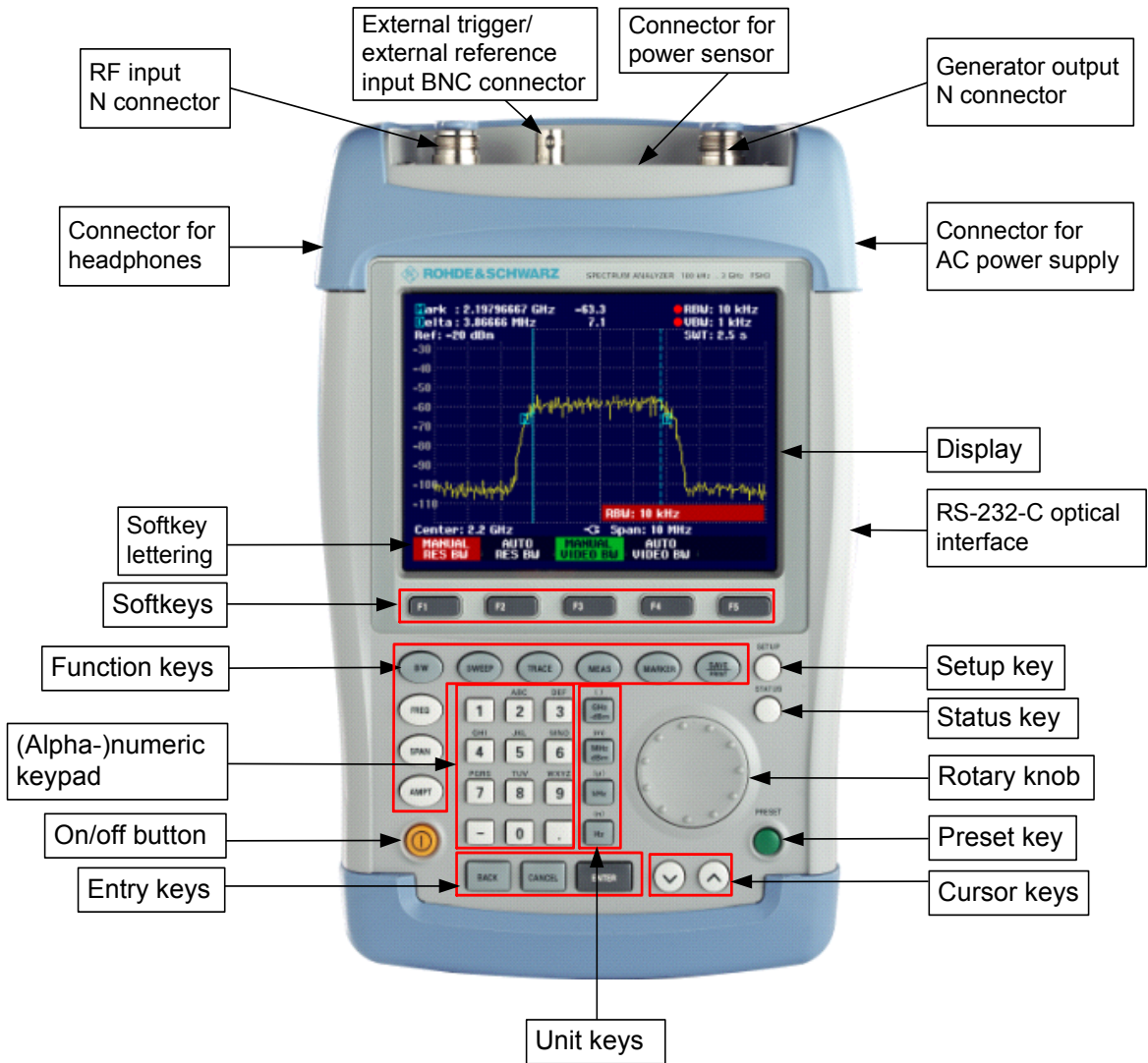

Putting into Operation

The following section describes how to put the handheld spectrum analyzer into operation and how to connect external devices, e.g. printers.

Section 2 describes the operation of the spectrum analyzer using simple measurements as examples.

Unpacking the Instrument

The R&S FSH comes in formfitting packaging that consists of upper and lower shells. The two shells are held together by tape.

The packaging contains all accessories supplied.

- Undo the tape to unpack the analyzer.

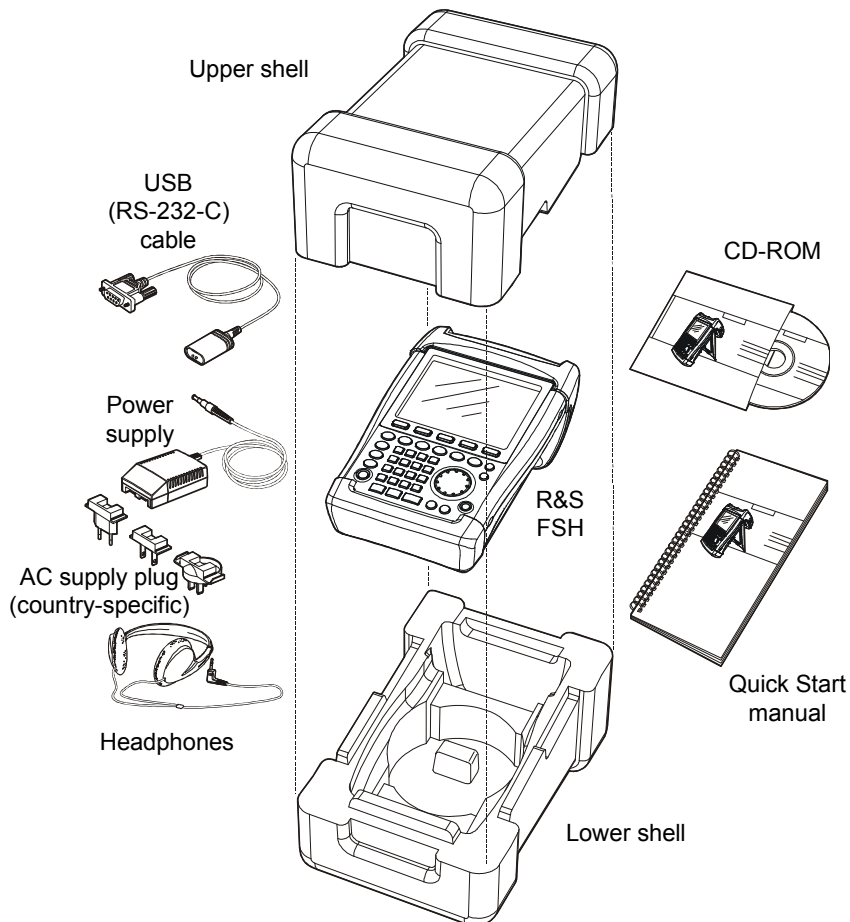

- Remove the R&S FSH and the accessories.
- Remove the protective foil from the screen.

Note: Each R&S FSH comes with a unique master PIN. Keep the master PIN in a secure place away from the R&S FSH. If someone enters an incorrect PIN three times in succession, the R&S FSH cannot be used again until the master PIN is entered.

Setting up the Instrument

The Handheld Spectrum Analyzer R&S FSH has been designed for operation in labs as well as for on-site use for service and maintenance applications.

For any application, the R&S FSH can be set up to optimize ease of operation and the viewing angle of the display.

When used as a desktop instrument, the R&S FSH can either be laid flat or it can be propped up using the fold-out support at the back.

The R&S FSH can be laid flat for operation from above. Because the grip is slightly raised at the back, the R&S FSH is tilted forward to give the optimum viewing angle for the display.

For use as a desktop, fold out the support at the rear so that the instrument can easily be operated from the front and the display can be read easily (see Fig.).

For on-site installation and service measurements, it is best to hold the instrument with both hands. All the controls are easy to reach (e.g. with your thumbs). Use the R&S FSH-Z25 carrying bag so that you have both hands free to adjust the DUT. The R&S FSH can be placed in the hanger provided on the open bag for this purpose.



To secure the instrument in place, affix its carrying handle to the front of the carrying bag with the Velcro tape.

The carrying handle at the top of the R&S FSH can also be used to hang it from cabinet doors, for example. The shape of the grip ensures that the instrument does not fall off.

Switching on the Spectrum Analyzer

The R&S FSH can be powered using either the included power supply unit or internal battery. When fully charged, the built-in nickel metal hydride battery provides an operating time of about four hours. On delivery, the battery in the R&S FSH may be flat. Therefore, it must be charged before the R&S FSH can be used. If the instrument is switched off, the charging time is seven hours.

When the AC power supply is used, the R&S FSH's battery is charged simultaneously.

Insert the jack plug of the power supply unit into the POWER ADAPTER connector on the right-hand side of the carrying handle so that it locks into position. Then connect the power supply unit to an AC outlet. The voltage range of the power supply unit is 100 V to 240 V.

Caution! Only the supplied power supply unit – the R&S FSH-Z33 – may be used to power the R&S FSH or charge the battery from the AC supply.



Prior to use, make sure that the AC supply voltage is compatible with the voltage specified on the power supply unit. Before inserting the power supply unit into the AC power outlet, attach the appropriate adapter.

In vehicles, the battery can be charged from the cigarette lighter socket using the Car Adapter R&S FSH-Z21.

Caution! Operation of the R&S FSH via the cigarette lighter socket while driving or while the engine is on is prohibited. During this time, the R&S FSH must be off.



While the battery of the R&S FSH is being charged via the 12 V Car Adapter R&S FSH-Z21 with the stock number 1145.5873.02, the car adapter must not be connected to the vehicle's ground (for example, via the RF connector) under any circumstances. This does not apply to the new R&S FSH-Z21 adapter with the stock number 1300.7579.02.

To switch on the R&S FSH, press the yellow button  at the bottom left of the front panel.

To indicate that it is connected to the AC supply, the R&S FSH displays a connector symbol in the middle of the display above the softkey labels.



When the R&S FSH is switched on, it recalls the settings that it was using when it was last switched off.

Note: If the internal battery is completely flat, the R&S FSH cannot be switched on even though it is connected to the AC supply via the power supply unit. In this case, the internal battery must be charged for a while with the instrument switched off. Only then can the instrument be switched on.

Spectrum Analyzer Connectors

The R&S FSH has the following connectors:

RF input

Connect the RF input via a cable with an N connector to the DUT. Make sure that it is not overloaded.

The maximum permissible continuous power at the RF input is 20 dBm (100 mW). It can be loaded with up to 30 dBm (1 W) for a maximum of three minutes. If the instrument is loaded with 1 W for longer, it heats up to such an extent that it may be destroyed.

Caution! *The RF input is AC-coupled. However, the DC input voltage must never exceed the value specified on the housing; otherwise the coupling capacitor at the input may be destroyed and, thus, the input attenuator or mixer as well. The RF input is protected from static discharges and voltage pulses by a combination of limiting circuits and high-voltage arresters.*



Input for external trigger or external reference (EXT TRIG/EXT REF)

Via the EXT TRIG/EXT REF BNC connector, either an external trigger signal is applied to start a measurement, or a 10 MHz reference signal is applied for frequency synchronization. The trigger threshold is similar to that of TTL signals. The level for the reference signal must be greater than 10 dBm. Switchover between external trigger input and reference input is via the SETUP key.

DC connector for external power supply (on the right-hand side of the carrying handle).

The DC connector is used to supply the R&S FSH with power from the AC/DC adapter and to charge the R&S FSH internal battery. The input voltage for the instrument must be between 15 V and 20 V. Power consumption is approx. 7 W.

The battery can also be charged from a cigarette lighter socket in a vehicle. The adapter is available as an R&S FSH accessory (R&S FSH-Z21, order no. 1145.5873.02).

Caution! *While the battery of the R&S FSH is being charged via the 12 V Car Adapter R&S FSH-Z21, the car adapter must not be connected to the vehicle's ground (for example, via the R&S FSH's RF connector or the power sensor) under any circumstances.*



Headphones connector (on the left-hand side of the carrying handle).

A 3.5 mm jack is provided for headphones. The internal impedance of the connector is approx. 10 Ω .

RS-232-C optical interface

(on the right-hand side of the R&S FSH, can be accessed by folding out the stand).

The RS-232-C optical interface is for connecting a printer or PC. The USB Optical Cable R&S FSH-Z37 (supplied with the R&S FSH) or the RS-232-C Optical Cable R&S FSH-Z34 available as accessory are used to make the connection. The optical connection prevents measurements as a result of interference from these devices. If you use the R&S FSH-Z37 USB optical cable, you need to install a software driver on your PC. The CD-ROM, which is supplied with the R&S FSH, includes both the driver and the installation instruction.

Use the Serial/Parallel Converter R&S FSH-Z22 for printers with a parallel interface.

Connector for power sensor

The connector has been especially configured for Rohde & Schwarz power sensors. The connector is used to power the sensor and to transfer data via the power sensor's interface. If the R&S FSH-Z2 (VSWR bridge up to 3 GHz) or R&S FSH-Z3 (VSWR bridge up to 6 GHz) is used, it is controlled by this connector.

Tracking generator output (models 1145.5850.13, 1145.5850.23 and 1145.5850.26 only)

Connect the tracking generator output to the DUT via an N connector. The nominal output level is -20 dBm (100 μ W). With the R&S FSH3 model 1145.5850.23, the level can be switched between -20 dBm and 0 dBm (1 mW). Up to 3 GHz, the R&S FSH6 model 1145.5850.26 supplies an output level of -10 dBm; above 3 GHz, the level is -20 dBm.



The output is AC-coupled and a voltage that does not exceed the voltage specified on the housing can be fed into the output; if this voltage is exceeded, the output may be destroyed.

Screen Settings

The R&S FSH's screen is a transfective, passive color LCD. Indoors, its brightness depends on the intensity of the backlighting. If light irradiation is strong, the ambient light supports readability. The viewing angle can be optimized by adjusting the contrast. To achieve maximum contrast, the screen can be switched from color display to black-and-white display.

To strike a balance between battery operating time and screen display quality, set backlighting to the minimum brightness needed.

Setting brightness

- Press the SETUP key.
- Press the DISPLAY softkey.

The submenu with the contrast, lighting and color settings opens.

- Using the rotary knob or cursor keys, select LIGHT... and confirm by pressing the DISPLAY softkey or the ENTER key again.



The BACKLIGHT submenu for the lighting level opens. The level can be set to HIGH, NORMAL and LOW.

- Using the rotary knob or cursor keys, select the setting you want and confirm by pressing the DISPLAY softkey or the ENTER key.



Setting the contrast

- Press the SETUP key.
- Press the DISPLAY softkey.

The submenu with the contrast, lighting and color settings opens.

- Using the rotary knob or the cursor keys, select CONTRAST... and confirm by pressing the DISPLAY softkey or the ENTER key again.



The contrast value entry box opens.

- Using the rotary knob, adjust the contrast until screen legibility is optimal.



When setting the contrast view the display at the same angle that will be used for the application.

- Confirm the entry with the ENTER key or by pressing the DISPLAY softkey again.

The R&S FSH displays the setting in the Display Contrast line in the overview of the setup settings.

Setting the screen color

- Press the SETUP key.
- Press the DISPLAY softkey.

The submenu with the contrast, lighting and color settings opens.



- Using the rotary knob or cursor keys, select TYPE... and confirm with the ENTER key or by pressing the DISPLAY softkey again.
- In the submenu that opens, select COLOR or BLACK/WHITE.
- Confirm with the ENTER key or by pressing the DISPLAY softkey again.

The R&S FSH switches to the selected color settings.



Country-Specific Settings

The R&S FSH is “multilingual” and can display text in the language of your choice. The softkey lettering is always in English. The default setting (factory-setting) is also English.

Selection

- Press the SETUP key.

The R&S FSH displays all default settings. The last two lines indicate the current language and the date format.



- Press the LOCAL SETTINGS softkey.

A submenu containing the text LANGUAGE... and DATE FORMAT... and UNIT OF LENGTH... opens. These menus allow you to enter a language and the date format.

- Using the rotary knob or cursor keys, select the LANGUAGE... you want from the menu and confirm with the ENTER key or by pressing the LOCAL SETTINGS softkey again.

The languages available are displayed in a submenu. The selected language is highlighted in red.



- Using the rotary knob or cursor keys, select the language you want.

The originally selected language is highlighted in green. The red bar indicates the new selection.

- Confirm the new selection with the ENTER key or by pressing the LOCAL SETTINGS softkey.

- Using the rotary knob or cursor keys, select DATE FORMAT... from the menu and confirm with the ENTER key or by pressing the LOCAL SETTINGS softkey again.
- Using the rotary knob or cursor keys, select the date format (dd/mm/yyyy or mm/dd/yyyy) and confirm with the ENTER key.
- Using the rotary knob or cursor keys, select UNIT OF LENGTH... from the menu and confirm with the ENTER key or by pressing the LOCAL SETTINGS softkey again.
- Using the rotary knob or cursor keys, select the required unit of length (METER or FEET) and confirm with the ENTER key.

Note: *The unit of length is relevant only with distance-to-fault cable measurements in order to display the fault distance from the measurement plane.*

Setting the Date and Time

The R&S FSH has an internal clock that can apply a date and time stamp, e.g. for output to a printer or stored data records. The user can reset the date and time.

Setting the date

- Press the SETUP key.
- Press the GENERAL softkey.
- Using the rotary knob or cursor keys, select DATE... from the menu and confirm with the ENTER key.

The value entry box above the row of softkey labels is highlighted in red and displays the currently set date in the selected format (dd/mm/yyyy or mm/dd/yyyy). The active value entry field is highlighted in white.



- Depending on the date format, change the day (dd) or month (mm) by using the rotary knob, cursor keys or a numeric entry and confirm with the ENTER key.

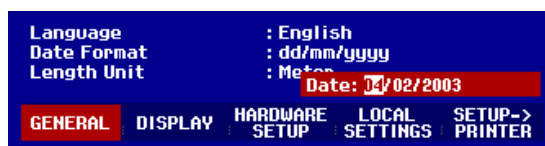

After the entry, the cursor automatically moves to the second field in the date (day or month, depending on the date format). Proceed with the next two fields as with the first.

After the last data block has been entered, the R&S FSH verifies the validity of the entered date. If the date is not valid, the R&S FSH sets the next valid date.

Setting the time

- Press the SETUP key.
- Press the GENERAL softkey.
- Using the rotary knob or cursor keys, select TIME... from the menu and confirm with the ENTER key.

The value entry box above the row of softkey labels is highlighted in red and displays the currently set time in hours:minutes format. The hours display is highlighted in white to enter a new value.



- Change the hours with the rotary knob, cursor keys or numeric entry and confirm with the ENTER key.

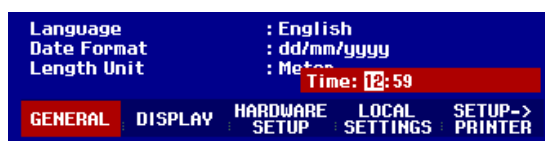

After entry, the cursor automatically goes to the minutes display. The entry is the same as for the hours display.

After the minutes have been entered, the R&S FSH verifies the validity of the entered time. If the time is not valid, the R&S FSH sets the next valid time.

Charging the Battery

The R&S FSH is fitted with a nickel metal hydride battery. Under the following conditions, the battery operating time is approx. four hours: fully charged battery, room temperature, tracking generator switched off.

Note: The battery in the R&S FSH is not charged when it leaves the factory. It must therefore be charged after delivery.

When stored over an extended period, self-discharging reduces the battery charge. The battery should therefore be charged before use if it is going to be the sole power source for a long period of operation.

The charging status of the battery is displayed by a symbol that looks like a battery in the middle of the screen above the row of softkey labels. If the battery is fully charged, the entire battery symbol is white. As the battery discharges, the white coloring disappears in five steps until just the battery outline indicates that the battery is flat.



Battery charge-level symbol

The battery is charged via the included power supply unit, which is connected to the jack on the right-hand side of the carrying handle.

If required, equip the power supply unit with the country-specific plug. Remove the plug from the power supply unit toward the front and firmly connect the appropriate plug to the power supply unit.

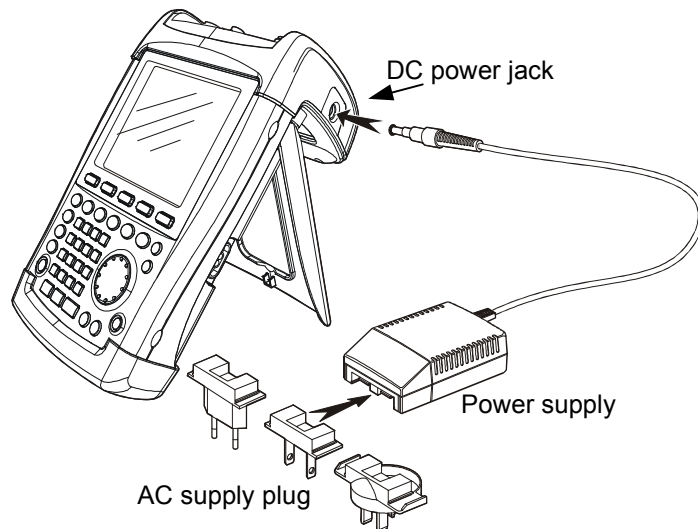

For rapid charging, be sure to switch off the R&S FSH during charging. The charging time is approx. seven hours.

If the R&S FSH is switched on, the charging current for the battery is reduced by the current drain of the R&S FSH, which means the battery might not be charged.

To prevent the battery from discharging unnecessarily, the R&S FSH has an automatic cut-off or auto power down mode that is activated if no entry is made for a definable period of time (5 minutes or 30 minutes).

The auto power down mode is deactivated in the default setting.

The auto power down mode is set as follows:

- Press the GENERAL key.

The R&S FSH opens the submenu with the general settings. The cursor is positioned to POWER DOWN in the menu.



- Confirm the POWER DOWN selection by pressing the ENTER key.

The R&S FSH opens a selection window with the settings: 5 minutes, 30 minutes and DISABLE.

- Using the rotary knob or cursor keys, select the setting you want and confirm by pressing the ENTER key or the GENERAL softkey. If the automatic power down function is activated, a ⏻ symbol will be displayed rather than the battery symbol.

Selecting the Instrument Default Setup

The PRESET key sets the R&S FSH to the default setup. This allows a new configuration based on defined measurement parameters to be entered, without parameters from a previous setting unintentionally still being active.

- Press the PRESET key.

The R&S FSH is set to the default setup. The span depends on the model. With the R&S FSH3, it is 3 GHz; with the R&S FSH6, 6 GHz, and up to 18 GHz with the R&S FSH18.

If certain parameters are always to deviate from the default setup for a specific application, it is also possible to select a user-defined default setup, which is then automatically set with the PRESET key. This is useful, for example, if the measurement is always made with a 75 Ω matching pad. When the PRESET key is pressed, the R&S FSH always selects 75 Ω as the input impedance for the user-specific default setup. The user-defined default setup is generated by manually entering the desired parameters and saving the setting as a data set. This data set can subsequently be declared the preset settings with the aid of the R&S FSH View software.

The data set designated as the preset settings becomes the default setup of the R&S FSH as follows:

- Press the SETUP key.
- Press the GENERAL softkey.
- Select PRESET SETTINGS from the menu using the cursor keys or the rotary knob.
- Confirm your choice with the ENTER key or the GENERAL softkey.



The submenu for selecting the default setup opens. Either DEFAULT or CUSTOM can be selected.

- Select CUSTOM from the menu using the cursor keys or the rotary knob.
- Confirm your choice with the ENTER key or the GENERAL softkey.



The parameters defined in the data set for the default setup are now used as the preset settings.

If no user-specific default setup is defined, CUSTOM is inactive and cannot be selected.

The data set defined as the user default setup can be viewed using the R&S FSH's recall function.

- Press the SAVE/PRINT key.
- Press the RECALL softkey.

All stored data sets are displayed.

The status of the data set is indicated in the status field:

- : Preset setting
- : Data set disabled

If no data sets are stored in the R&S FSH, the message "No datasets available" is output instead of the list of data sets.

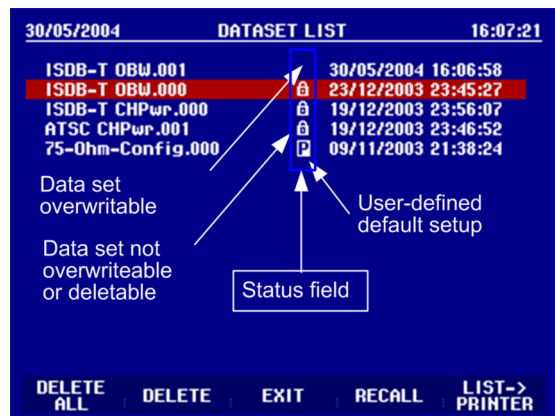

External Reference / External Trigger Switchover

The Ext Trig/Ext Ref BNC connector on top of the R&S FSH can be used either as an input for an external trigger or an external reference. Switchover is via the SETUP menu.

- Press the SETUP key.
- Press the HARDWARE SETUP softkey.
- Using the rotary knob or the cursor keys, select the menu item and confirm your choice with the ENTER key or the BNC I/O MODE softkey.

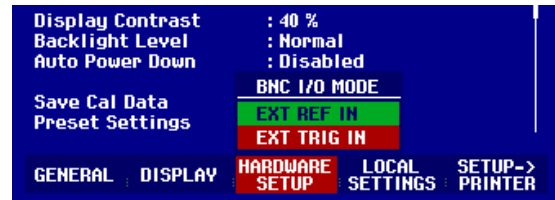

The active input setting (EXT TRIG IN or EXT REF IN) is highlighted in green.

- Using the rotary knob or cursor keys, select EXT REF IN or EXT TRIG IN.
- Confirm with the ENTER key or the HARDWARE SETUP softkey.

The EXT TRIG setting is only for input configuration. The use of the external trigger must be set in the SWEEP menu (SWEEP key, TRIGGER softkey).

If the input is configured for the external reference and if no reference signal is present at the input, a warning will appear on the screen. This is meant to prevent users from carrying out a measurement without a valid reference.

The input setting can be queried via the status display (press STATUS key).

Controlling the RF Attenuator

Depending on the selected reference level, the R&S FSH sets the attenuator on the RF input to a suitable value. It offers two modes: one for the highest possible sensitivity (LOW NOISE) and one for the lowest possible intermodulation products (LOW DISTORTION). The difference between the two modes is that the attenuation that the R&S FSH sets for the RF attenuator is 10 dB higher for LOW DISTORTION than for LOW NOISE.

- Press the SETUP key.
- Press the HARDWARE SETUP softkey.
- Using the rotary knob or cursor keys, select DYNAMIC RANGE... from the menu.
- Confirm with the ENTER key or the HARDWARE SETUP softkey.
- Using the rotary knob or cursor keys, select LOW NOISE or LOW DISTORTION.



Confirm with the ENTER key or the HARDWARE SETUP softkey.

Using a Preamp

(Only models 1145.5850.03, 1145.5850.23, 1145.5850.06 and 1145.5850.26)

The R&S FSH models 1145.5850.03, 1145.5850.23, 1145.5850.06 and 1145.5850.26 come with an internal preamplifier for increasing sensitivity. Depending on the frequency, this amplifier has 15 dB to 18 dB gain and increases sensitivity by 10 to 15 dB. It is fitted behind the RF attenuator and in front of the input mixer.

- Press the SETUP key.
- Press the HARDWARE SETUP softkey.
- Using the rotary knob or cursor keys, select PREAMP... .
- Confirm with the ENTER key or the HARDWARE SETUP softkey.

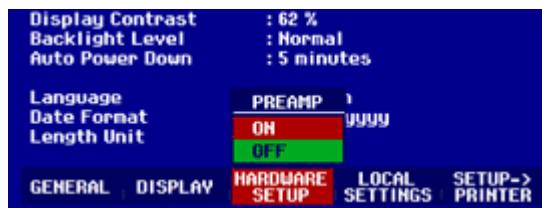

The R&S FSH changes to the submenu for preamplifier configuration. The selection bar indicates the active setting.

- Using the rotary knob or cursor keys, select the setting you want (ON or OFF) and confirm by pressing the ENTER key.

If the preamplifier is switched on, its use is coupled to the reference level, thus ensuring the optimum dynamic range of the R&S FSH at all times. The table below shows the positions of the RF attenuator and the preamplifier as a function of the reference level.

Reference level	Preamplifier OFF		Preamplifier ON		
	RF attenuation		RF attenuation		Preamplifier
	Low Noise	Low Distortion	Low Noise	Low Distortion	
≤-25 dBm	0 dB	0 dB	0 dB	0 dB	On
-24 dBm to -20 dBm	0 dB	0 dB	10 dB	10 dB	On
-19 dBm to -15 dBm	0 dB	10 dB	10 dB	10 dB	On
-14 dBm to -10 dBm	0 dB	10 dB	0 dB	10 dB	Off
-9 dBm to 0 dBm	10 dB	20 dB	10 dB	20 dB	Off
1 dBm to 10 dBm	20 dB	30 dB	20 dB	30 dB	Off
11 dBm to 20 dBm	30 dB	30 dB	30 dB	30 dB	Off

The attenuator position can be queried at any time via the status display.

PIN Entry

To prevent unauthorized use, the R&S FSH can be protected with a personal identification number (PIN).

When the R&S FSH is delivered, the PIN is set to 0000 and PIN entry is disabled when the R&S FSH is switched on. A PIN, i.e. a four-digit number, can be re-entered whenever you wish. But it is not activated until the PIN mode has been enabled.

A new PIN is entered as follows:

- Press the SETUP key to call up the SETUP menu and the instrument settings.
- Press the GENERAL softkey.



Using the rotary knob or cursor keys, select PINCODE... from the menu and press the ENTER key. The selection box with the PIN settings is opened.

The current PIN must be entered before it can be modified. This prevents unauthorized PIN modification.

- Enter your valid PIN.

When the R&S FSH is delivered, the valid PIN is 0000.

After you enter your valid PIN, the PIN functions can be selected from the selection box. When the R&S FSH is delivered, a new PIN can be activated only if it differs from the factory-set PIN.

Note: Before you activate the PIN mode, enter a user-defined PIN. Keep your PIN in a secure place away from the R&S FSH. If the active PIN is not available, the instrument can be reset to the default PIN ('0000') with the master PIN supplied with each instrument. If the master PIN is not available, please contact an authorized Rohde & Schwarz service center.

Entering a new PIN

- Using the rotary knob or cursor keys, select New Pincod... from the menu in the selection box and enter a new four-digit PIN. Confirm with ENTER.

The R&S FSH will prompt you to re-enter the PIN in order to prevent incorrect entries.

- Re-enter the PIN.

Activating the PIN mode

- Using the rotary knob or cursor keys, select PINCODE ON from the menu and press the ENTER key.

The R&S FSH now prompts you to enter the PIN prior to its activation.

- Enter the PIN and confirm with the ENTER key.

The selected PIN is now activated. The next time you switch on the R&S FSH, you must enter the PIN before you can operate the instrument. If you enter an incorrect PIN, the R&S FSH again prompts you for the PIN code. After three attempts with an incorrect PIN, the R&S FSH prompts you for the master PIN.

Note: The R&S FSH comes with labels reading 'PIN Code protected'. If the instrument is protected with a PIN, affix one of these labels to the instrument. This warns unauthorized users that they cannot operate the R&S FSH.

Deactivating PIN protection

- Using the rotary knob or cursor keys, select PINCODE OFF from the menu and press the ENTER key.

Prior to deactivation, the R&S FSH prompts you to enter your PIN. This prevents unauthorized deactivation of PIN protection.

- Enter your PIN number and confirm with the ENTER key.

The R&S FSH can now be operated without PIN protection.

Connecting a Printer

The R&S FSH can output a screenshot to a printer equipped with an RS-232-C interface. The optical RS-232-C cable R&S FSH-Z34 is available as an accessory. The Serial/Parallel Converter R&S FSH-Z22 is available as an accessory for printers with a parallel interface.

A printer with an RS-232-C interface can be directly connected using the RS-232-C optical interface cable R&S FSH-Z34.

- Fold out the stand at the rear of the R&S FSH.
- Connect the optical connector of the RS-232-C cable to the optical interface on the right-hand side of the R&S FSH.
- Connect the 9-pin D-Sub connector of the cable to the RS-232-C input of the printer.

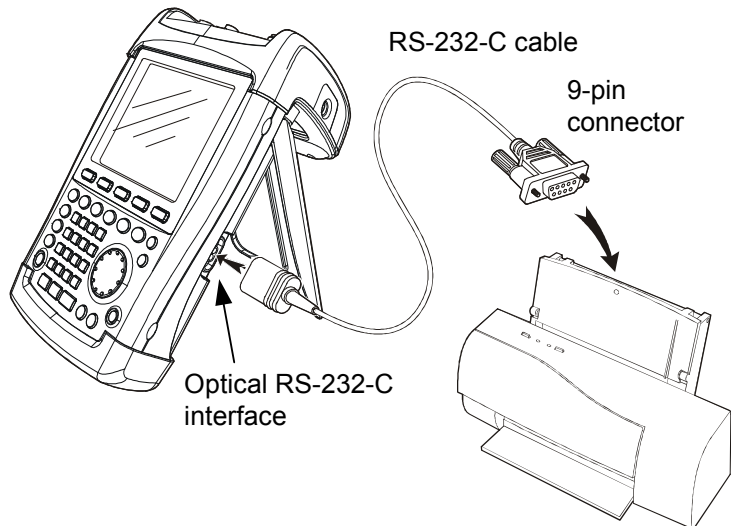

Connect printers with a parallel interface to the R&S FSH using the Serial/Parallel Converter R&S FSH-Z22, thus freeing up the Centronics parallel interface to connect a printer. The R&S FSH-Z22 is powered by a 9 V alkaline battery (NEDA, IEC6LR61).

- Fold out the stand at the rear of the R&S FSH.
- Connect the optical connector of the R&S FSH-Z22 to the optical interface on the right-hand side of the R&S FSH.
- Connect the printer cable to the 25-pin interface of the R&S FSH-Z22.
- Switch on the serial/parallel converter using the slide switch on its top.

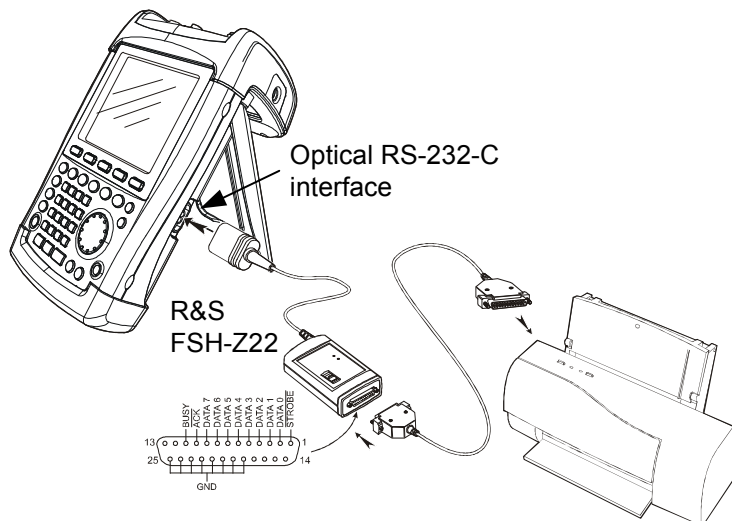

Slide switch positions:

- OFF The R&S FSH-Z22 is off.
- ON The R&S FSH-Z22 is on, and the Battery OK LED flashes.
- AUTO OFF The R&S FSH-Z22 is on, and the Battery OK LED flashes. If data transmission is interrupted for more than 5 minutes, the R&S FSH-Z22 is switched off automatically.

While data is being transmitted to the printer, the "Busy" LED remains lit.

Note: The R&S FSH-Z22 is designed for a data transmission rate of max. 38 400 baud (= default setting). Therefore, set the baud rate (PRINTER BAUD RATE) in the SETUP menu to 38 400 baud. The baud rates 9600 baud and 19 200 baud can also be set on the R&S FSH-Z22 by opening its housing.

Selecting a printer

- Press the SETUP key on the R&S FSH.

The R&S FSH displays the selected printer and its baud rate in the setup settings.

To select another printer, proceed as follows:

- Press the GENERAL softkey.
- Using the rotary knob or cursor keys, select PRINTER TYPE... from the menu and confirm with the ENTER key or by pressing the GENERAL softkey again.



- Using the rotary knob or cursor keys, select the printer you want and confirm with the ENTER key or by pressing the GENERAL softkey again.

The R&S FSH displays the selected printer under "Printer Type".



Next, set the baud rate for the selected printer.

- Press the GENERAL softkey.
- Using the rotary knob or cursor keys, select PRINTER BAUD... from the menu and confirm with the ENTER key.



The selection box for the available baud rates (1200 baud to 115 200 baud) opens.

- Using the rotary knob or cursor keys, select the baud rate you want and confirm with the ENTER key or by pressing the GENERAL softkey a second time.

The R&S FSH displays the selected baud rate under "RS232 Baudrate" in the setup display.



Note: If the serial/parallel converter (R&S FSH-Z22) is used to control a printer with a parallel interface, set the RS-232-C interface to 38400 baud.

The contents of the setup display can be output to the printer by pressing the SETUP -> PRINTER softkey.

Setting the Baud Rate for Remote Control

The R&S FSH offers different baud rates for remote control. The desired baud rate is set via the setup menu.

- Press the SETUP key.
- Press the GENERAL softkey.
- Use the rotary knob or the cursor keys to select SERIAL BAUD... from the menu and confirm the selection with the ENTER key.



The selection box for the available baud rates (9600 baud to 115200 baud) opens.

- Use the rotary knob or the cursor keys to select the baud rate you want and confirm the entry with the ENTER key or by pressing the GENERAL softkey again.

The R&S FSH displays the selected baud rate under SERIAL BAUDRATE in the setup display.

Enabling Options

The R&S FSH can be fitted with options (e.g. distance-to-fault measurements on cables) which are enabled by entering a key code. The key code is based on the unique serial number of the instrument. To add an option, enable it with a key code.

Operation

- Press the GENERAL key.
- Using the rotary knob or cursor keys, select OPTIONS... from the menu and confirm with the ENTER key.

Enter the key code (ten-digit number) for the option with the numeric keys and confirm with the ENTER key.

If the correct key code is entered, the R&S FSH displays "<...> Option enabled".

If an invalid key code is entered, the R&S FSH displays "Option key error".

The correct key code can then be entered.

Checking the Installed Options

The R&S FSH displays the installed options in the Setup menu so you can check them:

- Press the SETUP key.
- Using the rotary knob or the cursor keys, scroll the status display downwards.

The R&S FSH displays all available options together with their current status.



24/09/2004	INSTRUMENT SETUP	10:27:35
Display Contrast	: 75 %	▲
Backlight Level	: High	
Auto Power Down	: Disabled	
Save Cal Data	: On	
Preset Settings	: Custom	
Language	: English	
Date Format	: dd/mm/yyyy	
Length Unit	: Meter	
Distance to Fault (B1)	: Installed	
Vector Calibration (K2)	: Installed	
Remote Control (K1)	: Installed	
Receiver Mode (K3)	: Installed	
GENERAL	DISPLAY	HARDWARE SETUP
		LOCAL SETTINGS
		SETUP-> PRINTER

2 Getting Started

This section explains the basic operation of the Handheld Spectrum Analyzer R&S FSH using some simple measurements as examples. A more detailed description of operation and functions, such as selecting menus and setting measurement parameters, is given in section 3 of the manual on the CD-ROM.

Measurements on CW Signals

A basic task performed by spectrum analyzers is measuring the level and frequency of sinewave signals. The following examples illustrate the most effective way of performing these measurements with the R&S FSH.

A signal generator is used as a signal source, e.g. the Signal Generator R&S SML.

Measurement setup

Connect the RF output of the signal generator to the RF input of the R&S FSH.

Signal generator settings:

Frequency	100 MHz
Level	-30 dBm

Level Measurement

First, set the R&S FSH to its default settings to show all the operating steps that are required.

➤ Press the PRESET key.

The analyzer displays the frequency spectrum from 100 kHz to 3 GHz or 100 kHz to 6 GHz (dependent on the model) – the R&S FSH's maximum frequency span. At 100 MHz, the generator signal is displayed as a vertical line. Generator harmonics can also be seen as lines at frequencies that are multiples of 100 MHz.

To analyze the generator signal at 100 MHz in more detail, reduce the frequency span. Set the R&S FSH's center frequency to 100 MHz and reduce the span to 10 MHz.

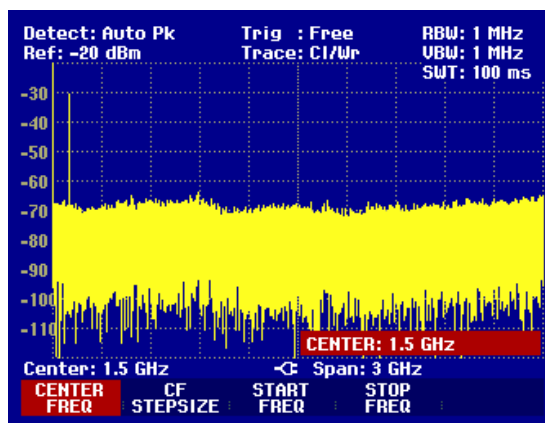

- Press the **FREQ** key.
- Enter “100” using the numeric keypad and confirm the entry with the **MHz** key.
- Press the **SPAN** key.
- Enter “10” using the numeric keypad and confirm the entry with the **MHz** key.

The R&S FSH now displays the generator signal with a higher resolution.

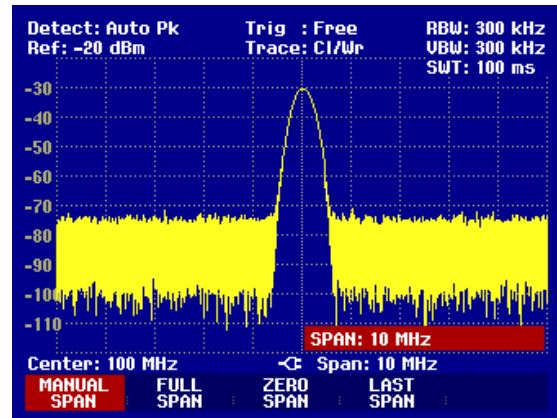

The R&S FSH has markers for reading off signal levels and frequencies. Markers are always positioned on the trace. Both the level and frequency at their current positions are displayed on the screen.

- Press the **marker** key.

The marker is activated and is automatically positioned on the trace maximum. A vertical line on the measurement diagram indicates the marker frequency. A short horizontal line on the trace indicates the level.

The R&S FSH displays the marker frequency and level numerically at the top of the measurement diagram.

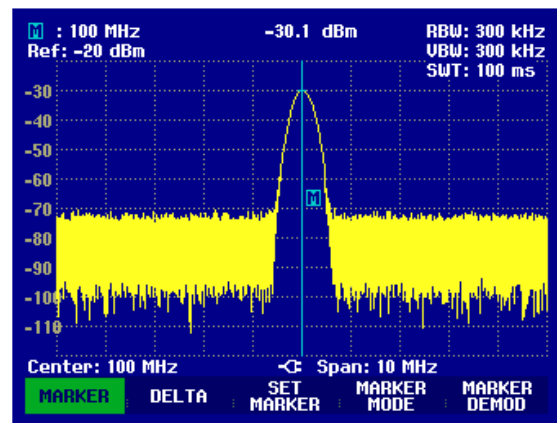

Setting the Reference Level

The level shown by spectrum analyzers at the top of the measurement diagram is called the reference level (REF LEVEL). To obtain the best dynamic range from a spectrum analyzer, its full level range should be used. This means that the maximum spectrum level should be at or close to the top of the measurement diagram (= reference level).

The reference level is the maximum level on the level axis (y axis).

Reduce the reference level by 10 dB to increase the dynamic range.

- Press the **AMPT** key.

The softkeys for the AMPT menu are displayed and the **REF LEVEL** softkey label is highlighted in red, i.e. it is enabled for value entry. The red value entry box at the bottom right-hand corner of the measurement diagram displays the current reference level.

- Enter “30” using the numeric keypad and confirm the entry with the **dBm** key.

The reference level is now set to -30 dBm. The maximum trace value is close to the maximum scale value of the measurement diagram. The increase in the displayed noise floor is minimal. The difference between the signal maximum and the displayed noise (i.e. the dynamic range) has, however, been increased.

Using markers is also an effective way to shift the trace maximum so that it coincides with the top of the measurement diagram. If the marker is positioned on the trace maximum (as in the example), the reference level can be set to the marker level by entering the following keystrokes:

- Press the MARKER key.
- Press the SET MARKER softkey.
- Select REF LVL = MRK LVL in the submenu by using the rotary knob or the cursor keys.
- Press the ENTER key.

The reference level is then set to the measured level indicated by the marker. Only a few keystrokes are needed to set the optimal reference level.

Frequency Measurements

The R&S FSH's trace displays 301 measurement points (associated with 301 frequency or time points along the x axis). The marker is always positioned on one of these measurement points. The R&S FSH calculates the marker frequency from the measurement point frequency, and the center frequency and frequency span that have been set. The measurement-point resolution, and consequently the accuracy of the marker frequency readout, therefore depend on the frequency span that has been selected.

The R&S FSH has a frequency counter to increase the accuracy of the marker-frequency readout. It stops the sweep at the marker position, counts the frequency and then continues the sweep.

The following measurement example is based on the previous example.

- Press the MARKER MODE softkey in the marker menu.

The marker mode selection box opens.

- Select FREQ COUNT from the selection box using the rotary knob or the cursor keys.
- Press the ENTER key.

The label 'M:' at the upper left-hand corner of the measurement diagram changes to 'C:' to tell you that the frequency counter has been switched on. The resolution of the frequency readout is now 1 Hz no matter what span has been set. The accuracy is determined by the R&S FSH's internal reference frequency. It is far higher than that of pixel-oriented, marker-frequency readout.

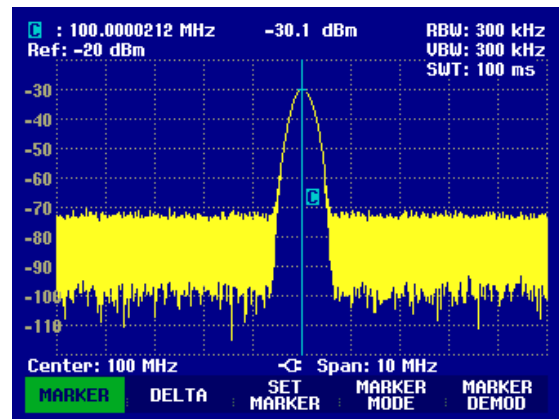

Harmonic Measurements of a Sinewave Signal

Since a spectrum analyzer can resolve different signals in the frequency domain, it is ideal for measuring harmonic levels or harmonic ratios. To speed up these operations, the R&S FSH has marker functions that deliver fast results with only a few keystrokes.

As above, a signal generator with a 100 MHz output frequency and an output level of -20 dBm is used in the following measurement example.

First, the R&S FSH is set to its default settings to show all measurement steps that are needed.

- Press the PRESET key.
The analyzer displays the frequency spectrum from 100 kHz to 3 GHz, the largest available span. At 100 MHz, the generator signal is displayed as a line. The generator harmonics are displayed as lines at frequencies that are multiples of 100 MHz.

To measure the second harmonic ratio, set the start and stop frequency as follows:

- Press the FREQ key.
The softkey menu opens entering the frequency.
- Press the START softkey.
- Enter '50' using the numeric keypad and confirm the entry with the MHz key.
- Press the STOP softkey.
- Enter '250' using the numeric keypad and confirm the entry with the MHz key.

The R&S FSH now displays the spectrum from 50 MHz to 250 MHz and thus the signal at 100 MHz and its second harmonic at 200 MHz.

To measure the harmonic ratio, set the marker on the fundamental and the delta marker on the second harmonic.

- Press the MARKER key.

The softkey menu opens for marker entry and automatically positions the main marker on the trace maximum.

- Press the DELTA softkey.

The delta marker is activated (vertical dotted line) and is automatically placed on the next trace maximum (= second harmonic).

The harmonic ratio in dB can be read directly from the numeric delta-marker display.

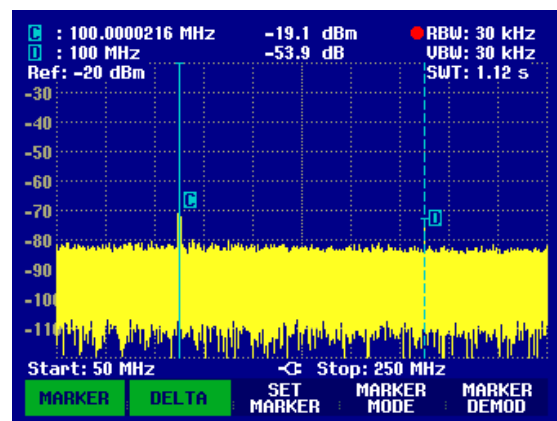

Power Measurements Using the Power Sensor

For highly accurate power measurements, the R&S FSH provides the Power Sensor R&S FSH-Z1 or R&S FSH-Z18 as options. They measure power in the span 10 MHz to 8 GHz or 10 MHz to 18 GHz, respectively.

The Power Sensor R&S FSH-Z1 or R&S FSH-Z18 is controlled and powered via a special RS-232-C interface at the top of the instrument.

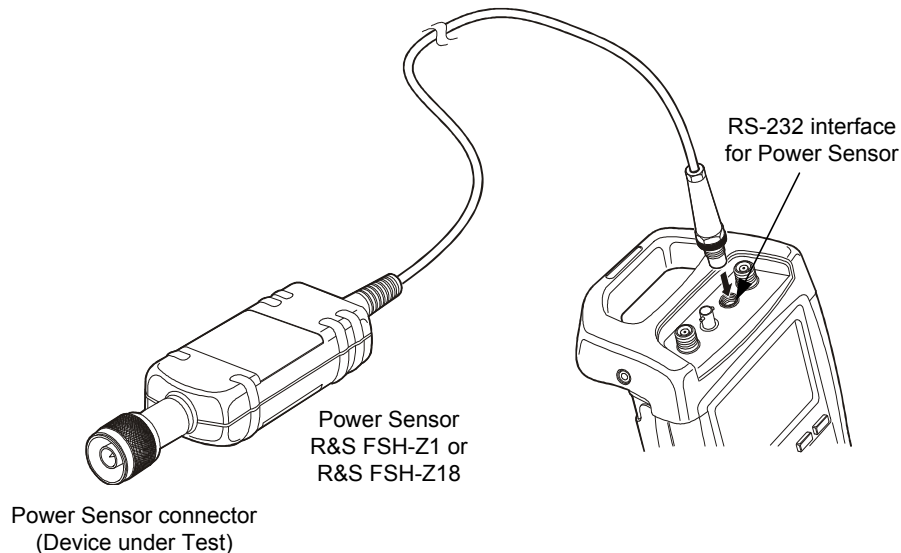

The continuous power applied to the power sensor's input must not exceed 400 mW (26 dBm). However, brief ($\leq 10 \mu\text{s}$) power peaks up to 1 W (30 dBm) are permissible. Higher input powers can destroy the sensor. An attenuator pad must be used to ensure that the maximum permissible power for the sensor is never exceeded when measurements are made on high-power transmitters.

- Connect the power sensor cable to the R&S FSH's power sensor connector and screw into position.
- Press the MEAS key.
- Press the MEASURE softkey.
- Using the cursor keys or the rotary knob, select the POWER SENSOR menu item and confirm your selection with the ENTER key or the MEASURE softkey.

The R&S FSH opens the screen for power measurements. If a power sensor has not been connected, no measured value is displayed. If a power sensor has been connected, the R&S FSH sets up a connection via the RS-232-C interface and, after a few seconds, displays the measured power.

If there are any communication problems with the power sensor, the R&S FSH outputs error messages (sensor error: error number) indicating the possible causes (see main manual).

To compensate for internal offset of the power meter, it needs to be compensated before starting the measurement.

- Press the ZERO softkey.

The R&S FSH outputs a message telling you not to apply any signals to the power meter while zeroing is being performed.

- Disconnect the power sensor from any signal sources.
- Start zeroing with the first or second softkey (CONTINUE).

The R&S FSH immediately starts power meter zeroing. While this process is being performed, the R&S FSH outputs the message "Zeroing power sensor, please wait..".

When zeroing is over, the R&S FSH outputs the message "Power Sensor Zero OK" and switches back to the softkey menu for the power sensor.

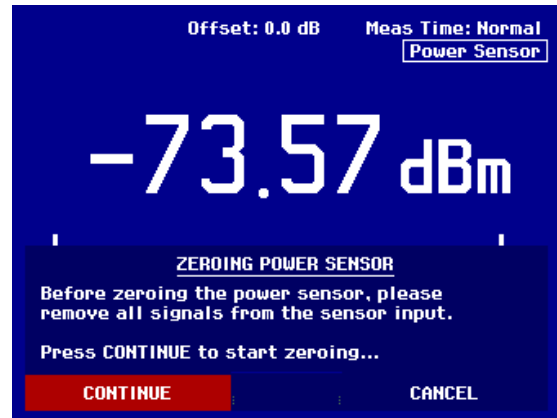

- Connect the signal under test to the R&S FSH-Z1 or R&S FSH-Z18.

The R&S FSH shows the measured power level in dBm.

For a highly accurate measurement, enter the frequency of the signal under test.

- Press the FREQ softkey.
- Using the numeric keys, enter the frequency you want and confirm the entry with the ENTER key or by pressing the FREQ softkey again.

The R&S FSH transfers the new frequency to the power sensor which then corrects the measured power readings.

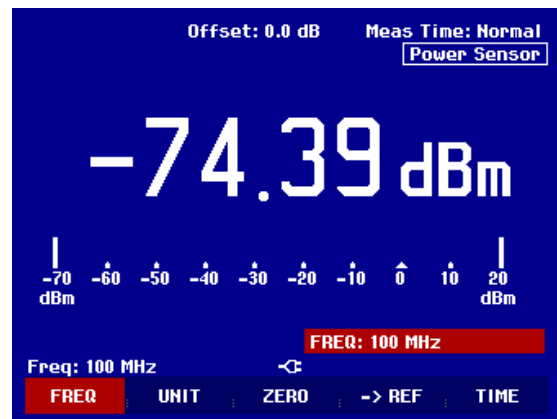

Power and Return Loss Measurements with the R&S FSH-Z14 or the R&S FSH-Z44

The Directional Power Sensors R&S FSH-Z14 and R&S FSH-Z44 are connected between the source and the load and measure the power flux in both directions, i.e. from the source to the load (forward power) and from the load to the source (reverse power). The ratio between reverse power and forward power is a measure of the load matching and is displayed as the return loss or standing wave ratio.

The R&S FSH-Z14 and the R&S FSH-Z44 have an asymmetrical design and must therefore be inserted into the test setup in such a way that the FORWARD arrow on the sensor points toward the load (= in the direction of the power flux).

They are driven and powered via a special serial interface.

The cable on the power sensor must be connected and screw-fastened to the power sensor connector on the R&S FSH. The directional power sensor itself has to be inserted between the source and the load.

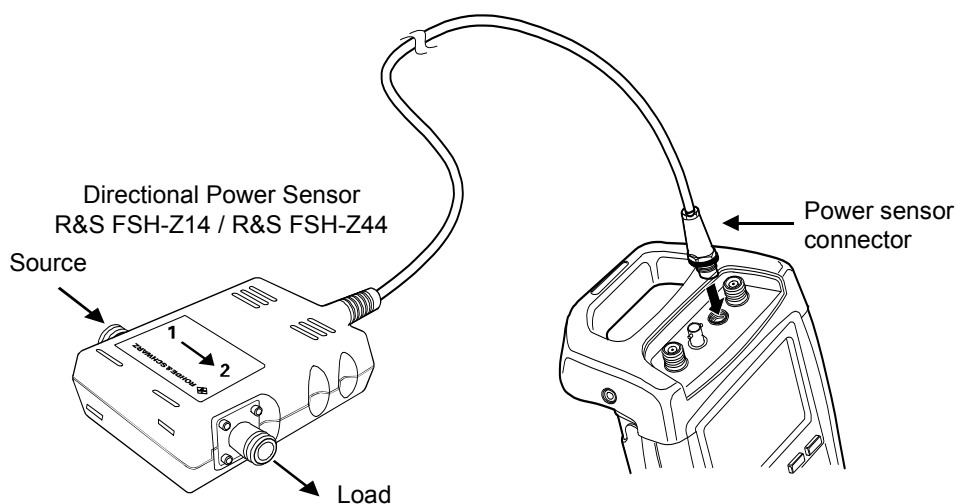

When measuring high powers, pay strict attention to the following instructions to avoid personal injury and to prevent the power sensor from being destroyed:



- Never exceed the permissible continuous power (see diagram on the rear of the sensor).
- Connect the sensor only when the RF power is off.
- The RF connectors must be screwed tight.

Failure to follow these rules can lead to injuries such as skin burns or cause the destruction of the measurement instruments in use.

Operation

- Press the MEAS key.
- Press the MEASURE softkey.

The R&S FSH opens the menu for the measurement functions.

Using the cursor keys or the rotary knob, select POWER SENSOR and confirm with the ENTER key or by pressing the MEASURE softkey.

The R&S FSH opens the screen and the menu for the power measurement. If no power sensor is connected, no measured value is displayed. If a power sensor is connected, the R&S FSH establishes a connection to the power sensor via the interface and, after a few seconds, displays the connected power sensor type (R&S FSH-Z14 or R&S FSH-Z44) as well as the measured forward power and return loss of the load.

Before performing the power measurement, zero the power sensor.

- Press the ZERO softkey.

The R&S FSH informs you not to apply any signals while the power sensor is being zeroed.

- Disconnect the power sensor from any signal sources.
- Start zeroing with the first or second softkey (CONTINUE).

Softkey 4 or 5 (CANCEL) can be used to cancel zeroing before it begins, e.g. if the signal source cannot be disconnected.

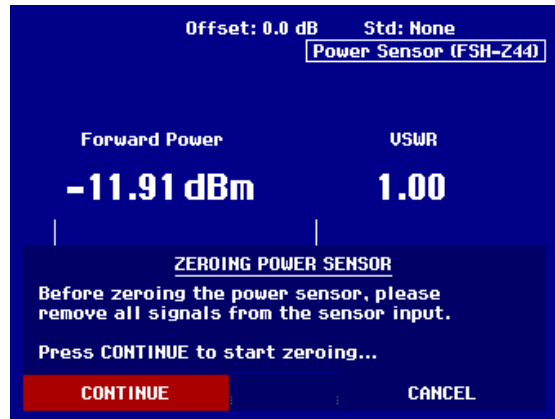

The R&S FSH immediately starts power sensor zeroing. While this is being done, the R&S FSH outputs the message "Zeroing power sensor, please wait...".

When zeroing is over, the R&S FSH outputs the message "Power Sensor Zero OK" and switches back to the softkey menu for the power sensor.

- Now connect the R&S FSH-Z14 or R&S FSH-Z44 between the source and the load.
- The R&S FSH displays the measured forward power level in dBm and the VSWR of the load..

To achieve maximum measurement accuracy, enter the frequency of the signal under test.

- Press the FREQ softkey.

The R&S FSH opens the entry box for the frequency.

- Using the numeric keys, enter the desired frequency and terminate the input with the ENTER key or by pressing the FREQ softkey again.

The R&S FSH transfers the new frequency to the power sensor which then corrects the measured power readings.

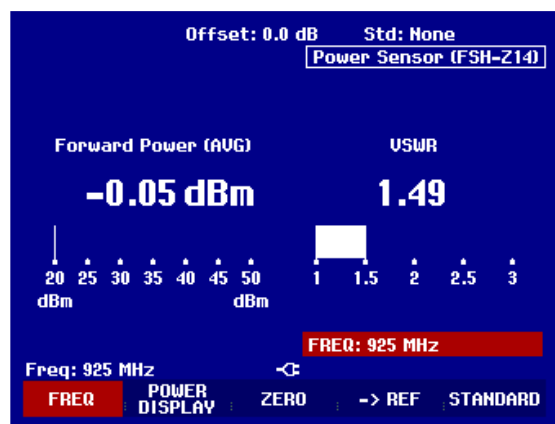

Two Port Transmission Measurements

(Only for R&S FSH with tracking generator: order no. 1145.5850.13, 1145.5850.23 or 1145.5850.26.)

For measurements of the gain or attenuation of two-port devices, the R&S FSH provides a tracking generator which generates a sinewave signal exactly at the receive frequency of the R&S FSH.

- Press the MEAS key.
- Press the MEASURE softkey.

The measurement function menu opens.

- Using the cursor keys or the rotary knob, select the TRACKING GEN menu item and confirm your selection with the ENTER key or the MEAS softkey.

The R&S FSH switches on the tracking generator and calls up its softkey menu.

When the tracking generator is switched on, the R&S FSH displays Track Gen Uncal. This indicates that tracking generator measurements are uncalibrated.

Before calibration, the span you want should be set because calibration is valid only for the calibrated span. Changing the frequency settings after calibration invalidates calibration.

- Press the FREQ key.
- Using the numeric keys, enter the center frequency.
- Press the SPAN key.
- Using the numeric keys, enter the span.

Alternately, the start and stop frequencies can be entered using the START and STOP softkeys in the frequency menu.

Calibrate the R&S FSH for the transfer function measurement.

The following example shows a scalar measurement of the transmission function. If the option R&S FSH-K2 is installed, the measurement must first be switched to scalar.

- Press the MEAS key.
- Press the MEAS MODE softkey.
- Using the rotary knob or cursor keys, select SCALAR.
- Confirm with the ENTER key or the MEAS MODE softkey.

- In the main menu for the tracking generator, press the MEAS key.
- Press the TRANSM CAL softkey.

The R&S FSH now prompts you to connect the RF input to the tracking generator's output so that calibration can be carried out.

- Connect the RF output to the generator's input without the DUT.
- Press the CONTINUE softkey to start calibration.

During calibration the R&S FSH outputs the message "Calibrating THROUGH, please wait..".

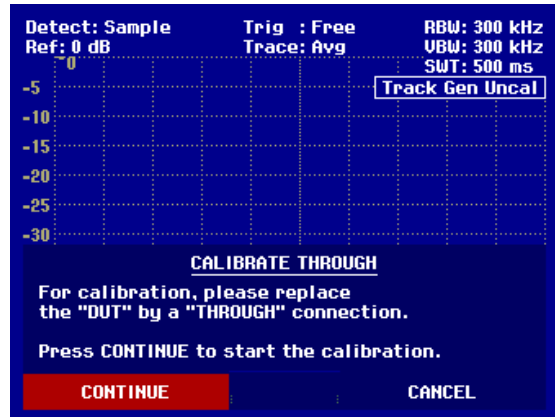

When calibration has been completed, the R&S FSH outputs the message "Transm. calibrated" for 3 seconds.

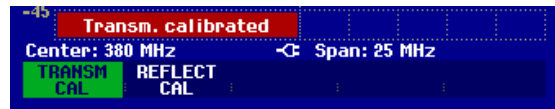

The R&S FSH now displays **Transmission** in the upper right-hand corner of the measurement diagram. This tells you that the R&S FSH has been calibrated for transfer function measurements. In addition, the TRANSM CAL softkey label is highlighted in green.

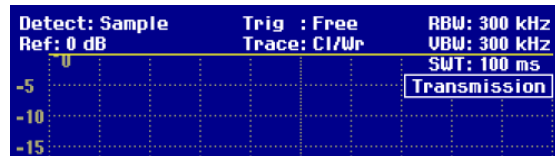

- Connect the DUT between the RF input and the generator's output.

The R&S FSH displays the magnitude of the transfer function. You can read out values with the markers, for example.

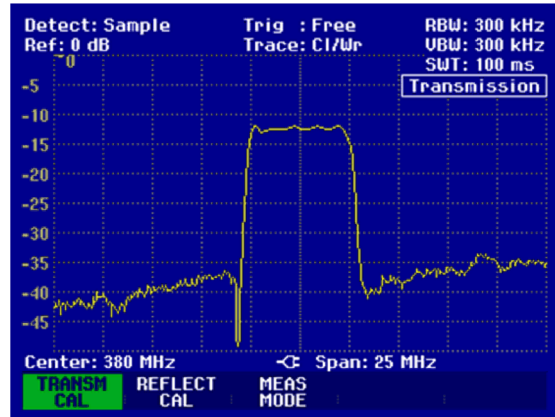

The transmission calibration remains valid until the center frequency or the span is changed on the R&S FSH. **Track Gen Uncal** is displayed in the upper right-hand corner of the screen if the calibration is no longer valid.

If the reference is changed after calibration, greater measurement uncertainty must be anticipated (up to 1 dB). The R&S FSH retains the calibration data but displays a red dot in front of **•Transmission**.

When saving a data set for a scalar transmission measurement in a calibrated state, the R&S FSH can store the calibration data along with the other settings (see section "Saving Calibration Data"). Thus, after the setting is recalled, a measurement can be performed without prior calibration, provided that the instrument's temperature does not deviate more than 5 °C from its temperature when the data set was stored.

If the temperature deviation is greater, the R&S FSH outputs a (red) dot in front of **• Transmission**. A precise measurement can then be made only after a calibration.

Measurement of Return Loss

(Only for R&S FSH with tracking generator: order no. 1145.5850.13, 1145.5850.23 or 1145.5850.26.)

For reflection measurements, the VSWR Bridge R&S FSH-Z2 (up to 3 GHz) or R&S FSH-Z3 (up to 6 GHz) and a short standard (supplied with the bridge) are needed. The VSWR bridge is screw-connected to the RF input connector and the generator's output.

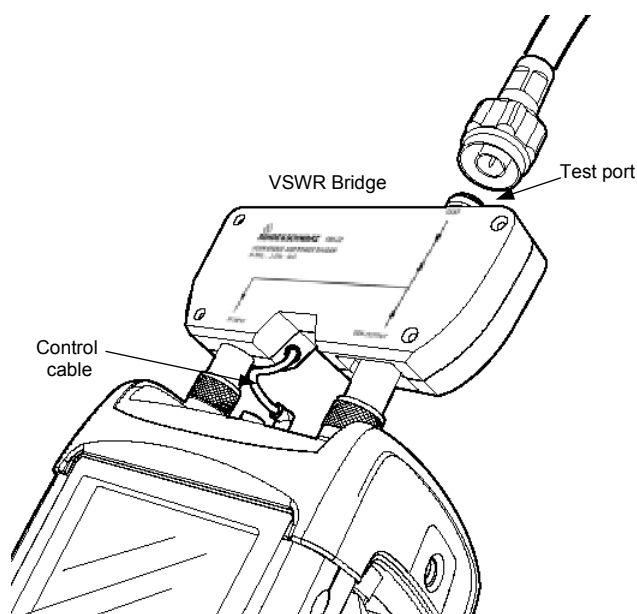

- Connect the control cable of the VSWR bridge to the power sensor connector of the R&S FSH.
- For measurements at DUTs that require external DC power (e.g. power amplifiers), connect the appropriate DC voltage to the corresponding Bias-T input of the VSWR bridge (R&S FSH-Z3 only).
- Connect the RF and generator port of the VSWR bridge to the RF input and generator output of the R&S FSH.

The test setup must be calibrated before any measurements are made. This is done with a short and an open standard at the point where the reflection measurement is to be made. If a cable is to be inserted between the DUT and the bridge, perform the calibration at the measurement end of the cable.

- Press the MEAS key.
- Press the MEASURE softkey.
- Using the cursor keys or the rotary knob, select TRACKING GEN from the menu and confirm with the ENTER key or the MEAS softkey.

The R&S FSH switches on the tracking generator and calls up its softkey menu. Since no calibration has been performed, `Track Gen Uncal` appears in the upper right-hand corner of the measurement diagram.

Before performing calibration, set the required span because calibration is valid only for the calibrated span. Changing the frequency settings after calibration invalidates calibration.

- Press the FREQ key.
- Using the numeric keys, enter the center frequency.
- Press the SPAN key.
- Using the numeric keys, enter the span.

Alternately, the start and stop frequency can be input using the START and STOP softkeys in the frequency menu.

Calibrate the R&S FSH for the return loss measurement.

The following example shows a scalar measurement of return loss. If the option R&S FSH-K2 is installed, measurement must first be switched to scalar.

- Press the MEAS key.
- Press the MEAS MODE softkey.
- Using the rotary knob or cursor keys, select SCALAR.
- Confirm with the ENTER key or the MEAS MODE softkey.
- In the main menu for the tracking generator, press the REFLECT CAL softkey.

The R&S FSH prompts you to leave the measurement port open.

- Leave the test port of the VSWR bridge open.
- Using the CONTINUE softkey, start the OPEN calibration.

While calibration is in progress, the R&S FSH outputs the message "Calibrating OPEN, please wait...".

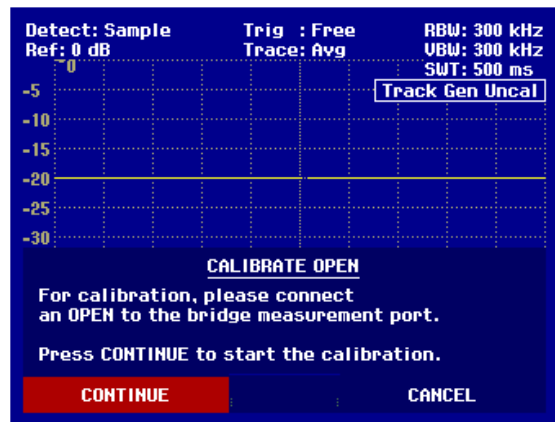

When OPEN calibration is over, the R&S FSH prompts you to perform SHORT calibration.

- Connect a short to the test port of the VSWR bridge.
- Using CONTINUE start the SHORT calibration.

While calibration is in progress, the R&S FSH outputs the message "Calibrating SHORT, please wait...".

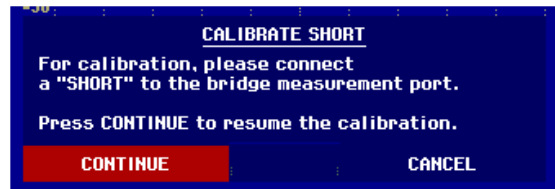

When calibration is over, the R&S FSH outputs the message "Reflect. calibrated" for 3 seconds.

Reflection is displayed in the upper right-hand corner of the measurement diagram to indicate that the R&S FSH is calibrated for reflection measurements.



- Connect the DUT to the measurement port of the VSWR bridge.

The R&S FSH displays the return loss of the DUT.

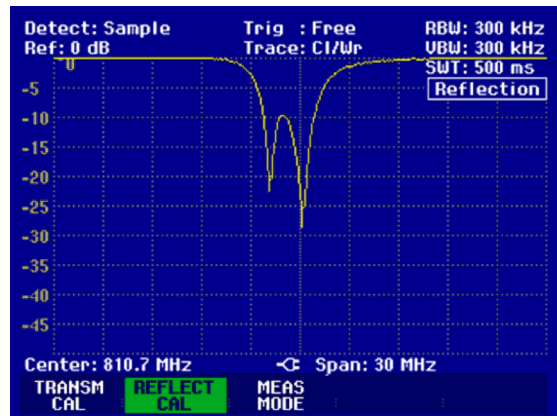

The transmission calibration remains valid until the R&S FSH's center frequency or span is changed. If calibration becomes invalid, the R&S FSH displays **Track Gen Uncal** in the upper right-hand corner of the screen.

If the reference is changed after calibration, a larger measurement uncertainty must be anticipated. The R&S FSH retains the calibration data but places a red dot in front of the **• Reflection** display to indicate possible increase in measurement uncertainty.

When saving a data set for a scalar reflection measurement in a calibrated state, the R&S FSH can store the calibration data along with the other settings (see section "Saving Calibration Data"). Thus, after the setting is recalled, a measurement can be performed without prior calibration, provided that the instrument's temperature does not deviate more than 5 °C from its temperature when the data set was stored.

If the temperature deviation is greater, the R&S FSH outputs a (red) dot in front of **• Reflection**. A precise measurement can then be made only after a calibration.

Performing Distance To Fault Measurements

(Only for the R&S FSH with the tracking generator (order no. 1145.5850.13, 1145.5850.23 or 1145.5850.26), installed option R&S FSH-B1 (distance-to-fault measurement) and VSWR Bridge R&S FSH-Z2 or R&S FSH-Z3.)

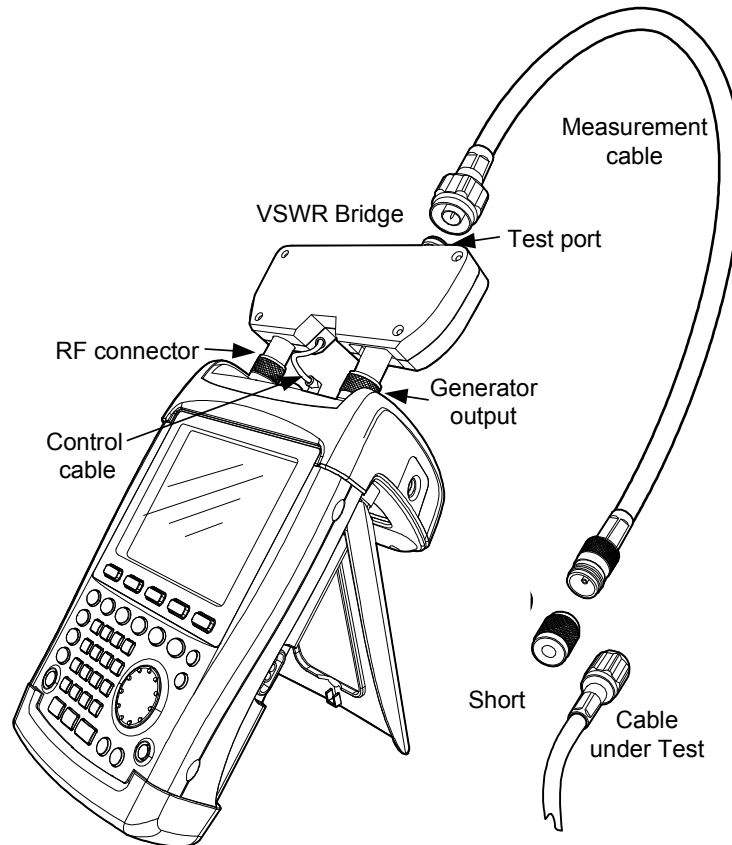

- Connect the control cable of the VSWR bridge to the power sensor connector of the R&S FSH.
- For measurements at DUTs that require external DC power (e.g. power amplifiers), connect the appropriate DC voltage to the corresponding Bias-T input of the VSWR bridge (R&S FSH-Z3 only).
- Connect the RF and generator port of the VSWR bridge to the RF input and generator output of the R&S FSH.
- Connect the 1 m test cable supplied with option R&S FSH-B1 to the bridge test port.

Note: The 1 m cable must be used. Results are invalid without this cable.

- Press the MEAS key.
- Press the MEASURE softkey.
- Using the cursor keys or rotary knob, select DISTANCE TO FAULT from the menu and confirm with the ENTER key or the MEAS softkey.

The R&S FSH switches on the distance-to-fault measurement function.

The R&S FSH delivers optimum results if the center frequency is set to the frequency at which the device under test is operated.

- Press the FREQ key.
- Input the center frequency, e.g. frequency of the antenna at the end of the cable under test.

To perform distance-to-fault cable measurements, the R&S FSH needs to be informed about the type of cable and its approximate length. Frequency-dependent cable models can be generated with the supplied R&S FSH View software for Windows and loaded onto the R&S FSH. The procedure is described in the R&S FSH View manual. The cable parameters for a frequency can also be entered directly.

Selecting a cable model from the list

- Press the MEAS key.
- Press the CABLE MODEL softkey.

The R&S FSH displays the list of loaded cable models.

- Using the rotary knob or the cursor keys, select the appropriate cable model.
- Using the SELECT softkey, activate the cable model you have selected.

The analyzer returns to the DTF measurement menu and displays the cable used for the measurement in the upper right-hand corner of the screen.



Entering the cable parameters at a specific frequency

If cables are used that are not listed in cable models stored in the R&S FSH, it is possible to enter the cable parameters at a specific frequency. It is advisable to use the center frequency of the DTF measurement.

- Press the MEAS key.
- Press the CABLE MODEL softkey.

The R&S FSH displays the list of loaded cable models (if available).

- Press the SELECT USER MOD softkey.

The softkey is highlighted in green to indicate that a user-specific cable model has been chosen.

The cable model is defined with the DEFINE USER MOD softkey.

- Press the DEFINE USER MOD softkey.

The R&S FSH opens a submenu for defining the FREQUENCY, the VELOCITY FACTOR and the ATTENUATION.



- Using the rotary knob or the cursor keys, select the appropriate parameter from the submenu and press the ENTER key.
- Enter the value (e. g. velocity factor) for the cable used.
- Confirm with the ENTER key.



Please refer to the cable manufacturer's data sheet for the velocity factor (= speed of the wave in the cable relative to the speed of light) and the attenuation of the cable per meter or per foot at the specified frequency.

- Use the EXIT softkey to exit the menu for defining the cable model.

The analyzer returns to the DTF measurement menu and displays the cable used for the measurement in the upper right-hand corner of the screen.

The R&S FSH uses the cable length to determine the optimal span for the measurement and for scaling the x axis in DTF mode. For best results, the cable should be specified 20% to 50% longer than the actual cable length.

- Press the CABLE LENGTH softkey.

The R&S FSH opens the cable length (CABLE LEN) value entry box and displays the current length setting.

- Using the numeric keys, enter the cable length in meters and terminate the entry with the ENTER key or one of the unit keys, or
- Using the rotary knob (1 m steps) or the cursor keys (10 m steps), adjust the cable length.

If the unit of length is set to Feet (via SETUP: LOCAL SETTINGS), the entry is in feet.

The minimum cable length is 3 m. The maximum cable length that can be set is 1000 m.

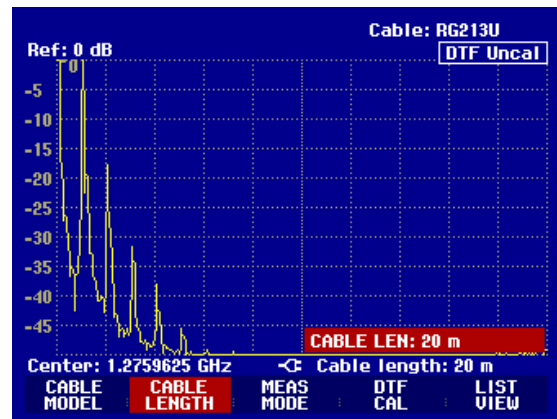

Calibrating the test setup

The test setup must be calibrated before any measurements are performed.

- Press the DTF CAL softkey.

The R&S FSH opens a text window that prompts you to terminate the measurement cable with a SHORT.

- Firmly screw the SHORT to the output end of the measurement cable.
- Press the CONTINUE softkey to start the SHORT calibration.

While the SHORT calibration is in progress, the R&S FSH outputs the message "Calibrating SHORT, please wait...".

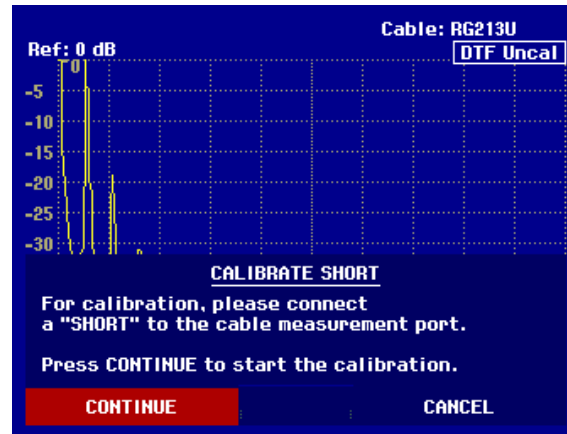

When calibration is over, the R&S FSH displays **DTF CAL** in the top right-hand corner of the screen.

Calibration tip

The R&S FSH performs calibration over its entire span. Therefore, recalibration is not necessary after the cable length is changed. The calibration data is stored in the R&S FSH memory. Thus, the calibration is valid after the operating mode is changed or after the instrument is switched off. For a calibration to remain valid, the instrument temperature must not deviate more than 5°C. If the temperature deviates more than this amount, the R&S FSH shows a red dot in front of the **DTF display**. A new calibration is then necessary.

- Screw the cable under test to the measurement cable.

The R&S FSH displays the return loss produced in the cable under test versus the distance.

The R&S FSH can also list any cable faults. It displays the return loss and distance from the measurement plane of all reflections that exceed a definable threshold.

- Press the LIST VIEW softkey.

The R&S FSH opens the threshold value entry box and also displays the threshold as a horizontal line across the measurement diagram.

- Set the threshold using the cursor keys (5 dB steps), the rotary knob (1 dB steps) or the numeric keys.

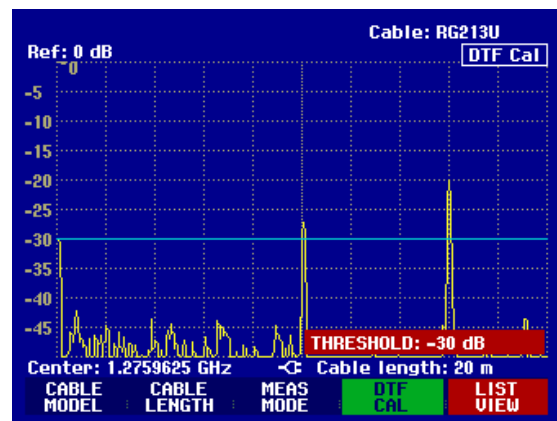

- Press the ENTER key or the LIST VIEW softkey again.

The R&S FSH displays a table listing all the return losses that are above the threshold, sorted according to distance from the measurement plane.

- To close the list and to return to the graphical display mode, press the EXIT softkey.

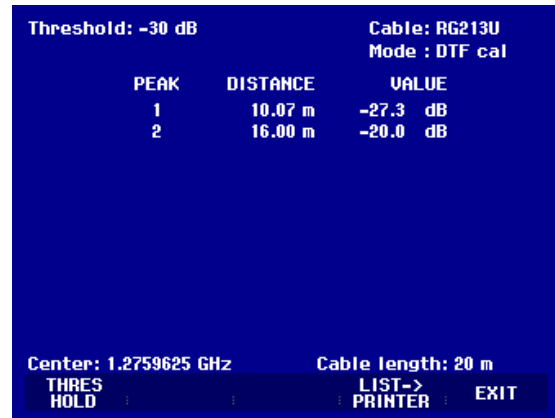

The distance to the cable faults or the distance between any two faults can also be read out with the marker.

- Press the MARKER key.

The R&S FSH opens the marker menu and places the distance marker on the largest return loss. The marker readout provides the distance of the reflection from the measurement plane in meters and its return loss.

- Change the distance marker by entering a number, adjusting the rotary knob (pixel by pixel) or by using the cursor keys (step = 10 % of the span).



For higher fault resolution, the R&S FSH offers a zoom function in the position of the marker. The x axis of the display can be extended up to a span of 3 m.

- Press the MARKER MODE softkey.
- Using the rotary knob or the cursor keys, select ZOOM ON from the menu.
- Confirm with the ENTER key.

The entry field for the zoom factor is displayed while the R&S FSH simultaneously expands the x axis by a factor of 2.

- Using the rotary knob or the cursor keys, set the zoom factor to the value you want.

The screenshot on the right shows that the fault of the measured cable consists of two transitions. A coupling of approx. 7 cm in length was used to connect two cables.

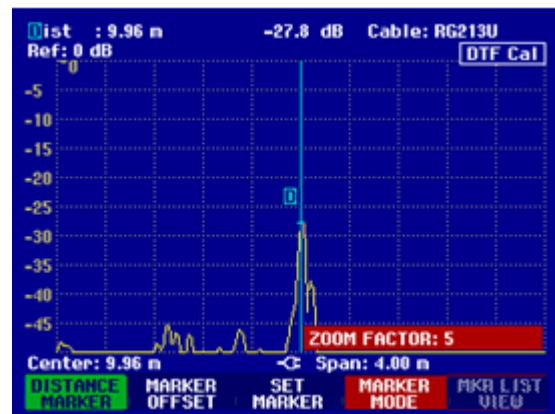

Disable the zoom function as follows:

- Press the MARKER MODE softkey in the MARKER menu.
- Using the rotary knob or the cursor keys, select ZOOM OFF from the menu.
- Confirm your selection by pressing the ENTER key or by pressing the MARKER MODE softkey again.

Checking the return loss of the cable under test:

- Press the MEAS MODE softkey.
- Select REFLECTION using the rotary knob or the cursor keys.
- Confirm by pressing the MEAS MODE softkey again or by pressing the ENTER key.

The R&S FSH measures the return loss over the span that has been selected for the distance-to-fault cable measurement.

To indicate that the R&S FSH is measuring return loss, **DTF refl. cal** is displayed in the upper right-hand corner of the screen.

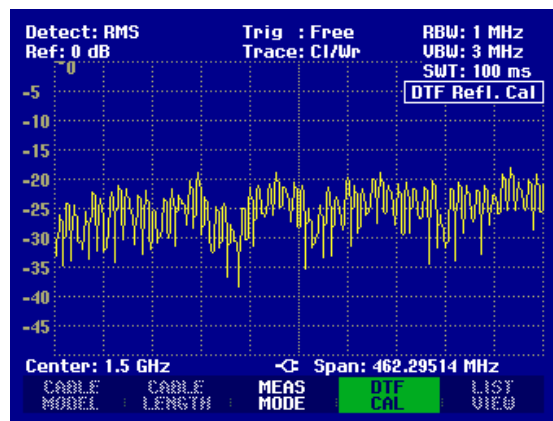

Checking the spectrum in the span for detecting external interferers:

- Press the MEAS MODE softkey.
- Select SPECTRUM using the rotary knob or the cursor keys.
- Confirm your selection by pressing the MEAS MODE softkey again or by pressing the ENTER key.

The R&S FSH turns off the tracking generator and displays the spectrum over the span of the DTF measurement.

To indicate that the R&S FSH is in the spectrum mode, **DTF Spectrum** is displayed in the upper right-hand corner of the screen. Otherwise, the R&S FSH uses exactly the same settings as it did for DTF measurements.

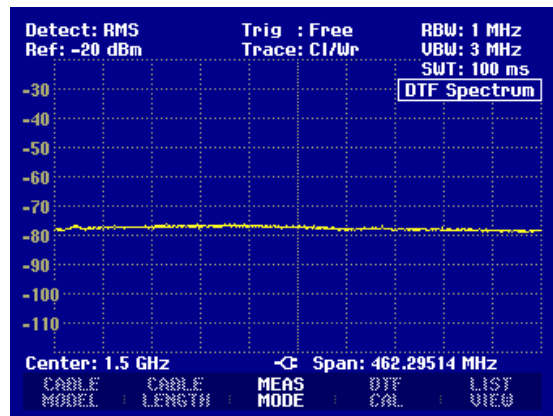

Operation in Receiver Mode

(Available only if the option R&S FSH-K3 is installed.)

To provide a means of measuring levels at a specific frequency, the R&S FSH offers the receiver mode as an option (option R&S FSH-K3). With this option, the R&S FSH functions like a receiver that measures the level at a predefined frequency.

Switching on the receiver mode:

- Press the MEAS key.
- Press the MEASURE softkey.

The R&S FSH opens the menu for measurement functions.

- Using the cursor keys or the rotary knob, select RECEIVER and confirm with the ENTER key or MEASURE softkey.

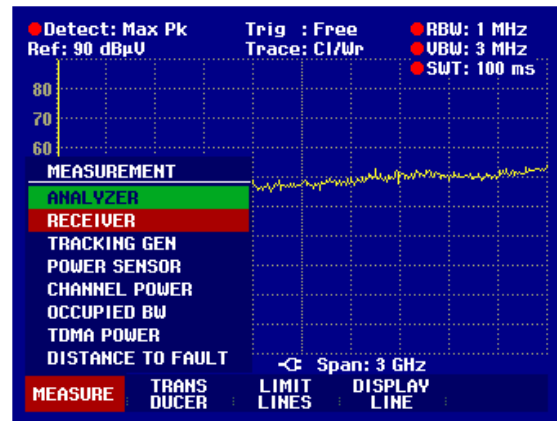

The R&S FSH activates the receiver mode and measures the level at the specified frequency.

The most important settings for the measurement parameters are provided directly in the main menu of the receiver mode, or they can be entered using the corresponding keys.

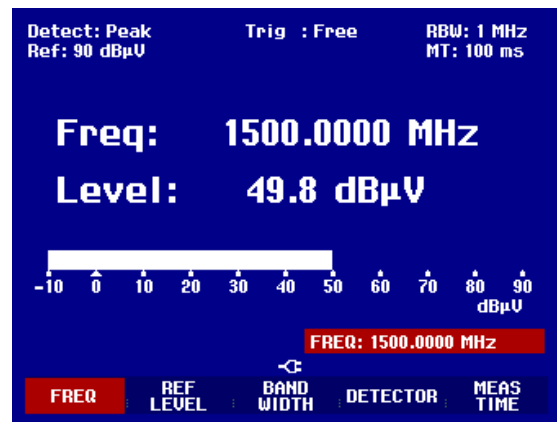

Setting the frequency

- Press the **FREQ** softkey in the main menu of the receiver mode.
- Using the rotary knob or the cursor keys, adjust the frequency, or, using the numeric keys, enter a new frequency and confirm the entry with the **ENTER** key.

You can also enter the frequency by using the **FREQ** key.

Selecting the frequency step size

The frequency resolution in the receiver mode is 100 Hz. The tuned step size can be changed as required for the application

- Press the **FREQ** key.
- Press the **FREQ STEPSIZE** softkey.
- Set the required step size in the selection table.
- Confirm with the **ENTER** key.
- You can set any step size you want by using **MANUAL...**
- To do so, select **MANUAL...** for the step size in the selection table.
- Using the rotary knob or cursor keys, change the tuned step size and confirm with the **ENTER** key, or, using the numeric keypad, manually enter a step size and confirm by pressing the units key.



Tuning the frequency in channel grids

As an alternative to entering the frequency, the R&S FSH can also be tuned in channels. The channel tables that the R&S FSH uses to set channel frequencies are defined either by using the R&S FSH View software or by directly entering the first channel number, the associated frequency, the number of channels and the channel spacing.

- Press the **FREQ** key.
- Press the **CHANNEL MODE** softkey.

The R&S FSH now uses the active channel table. The **FREQ** softkey for frequency entry is renamed to **CHANNEL** for channel entry, and the R&S FSH displays the channel number rather than the frequency. The channel numbers are now used to tune the frequency.

Selecting a channel table that was predefined using R&S FSH View

- If the channel display is active (**CHANNEL MODE** softkey active in the **FREQ** menu), press the **CHANNEL TABLE** softkey.

The R&S FSH will display the stored channel tables.

- Using the rotary knob or cursor keys, select the channel table you want.
- To activate the channel table, press the **SELECT** softkey.

01/04/2004	BAND TABLE LIST	22:40:09
TU France	01/03/2004 15:59:02	
TU Japan	01/03/2004 14:58:52	
TU DK_DIRT	01/03/2004 14:40:20	
TU Australia	01/03/2004 14:40:08	
TU Europe	01/03/2004 14:39:56	
TU China	01/03/2004 14:34:40	
TU Italy	01/03/2004 14:30:40	
TU Ireland	01/03/2004 14:30:26	
TU French Overs	01/03/2004 14:30:16	
PCS UL	01/01/1995 02:00:00	
PCS DL	01/01/1995 02:00:00	
GSM UL	01/01/1995 02:00:00	
GSM DL	01/01/1995 02:00:00	

At the bottom of the screen, there are several softkey options: SELECT, SELECT USER TAB, EXIT, DEFINE USER TAB, and LIST-> PRINTER.

Direct entry of a channel table

- If the channel display is active (CHANNEL MODE softkey active in the FREQ menu), press the CHANNEL TABLE softkey.
- Press the SELECT USER TAB softkey.

The R&S FSH will use the last channel table that was entered directly.

- Press the DEFINE USER TAB softkey.

The R&S FSH will open the submenu for defining the channel table.



- Press the DEFINE USER TAB softkey again.
- Enter the number of the first channel and confirm with the ENTER key.
- Press the DEFINE USER TAB softkey.
- Using the rotary knob or the cursor keys, select 1ST CHANNEL FREQ... from the menu and confirm with the ENTER key.
- Enter the frequency for the first channel number.
- Press the DEFINE USER TAB softkey.
- Using the rotary knob or the cursor keys, select NO OF CHANNELS... from the menu and confirm with the ENTER key.
- Enter the number of channels and confirm with the ENTER key.
- Press the DEFINE USER TAB softkey.
- Using the rotary knob or the cursor keys, select CHANNEL SPACING... from the menu and confirm with the ENTER key.
- Enter the frequency spacing for the channels and confirm with the ENTER key.
- Press the EXIT key to exit the menu for defining channel tables.

The R&S FSH will now show channel numbers rather than the frequency. It also shows the associated frequency above Channel.

Selecting the reference level

The reference level is the maximum level of the analog bar-graph display. It must be set such that the level display is located within the bar-graph scale.

- Press the REF LEVEL softkey in the main menu of the receiver mode (MEAS key). Or press the AMPT key.
- Using the rotary knob or cursor keys, change the reference level or, using the numeric keys, enter a new reference level.
- Confirm with the ENTER key.

Selecting the bandwidth

The receiver mode provides the same bandwidths as in analyzer operation. In addition, the three bandwidths 200 Hz, 9 kHz and 120 kHz are available for EMI measurements in accordance with CISPR16.

- Press the BW key
- Using the rotary knob or cursor keys, change the bandwidth and confirm with the ENTER key, or, using the numeric keypad, manually enter bandwidth and confirm by pressing the units key.
- For input of a CISPR bandwidth press the softkey CISPR BW.
- Using the rotary knob or cursor keys, change the bandwidth and confirm with the ENTER key, or, using the numeric keypad, manually enter bandwidth and confirm by pressing the units key.

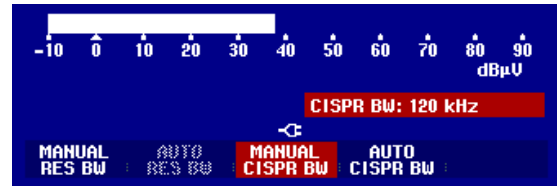

According to CISPR16 the bandwidth is connected to the frequency. The R&S FSH allows to couple the bandwidth to the set frequency automatically:

- Press the softkey AUTO CISPR BW.

The R&S FSH uses the suitable bandwidth dependent on the set frequency.

Setting the detector

The receiver mode of the R&S FSH offers a peak detector, average detector, RMS detector and quasi-peak detector.

Set the detector either from the main menu of the receiver mode or by using the TRACE key.

- Press the DETECTOR softkey in the main menu of the receiver mode, or press first the TRACE key and then the DETECTOR softkey
- Using the rotary knob or cursor keys, select a detector from the selection list.
- Press the ENTER softkey.



Setting the measurement time

The measurement time is the amount of time during which the R&S FSH collects measured values and compiles them into a display result for the selected detector.

- Press the MEAS TIME softkey in the main menu of the receiver mode, or press the SWEEP key.
- Using the rotary knob or cursor keys, adjust the measurement time, or, using the numeric keys, enter a new measurement time and confirm with the unit.

Note: If the quasi-peak detector is selected, the selected measurement time must be larger than 100 ms in order to ensure that fluctuating or pulse-like signals are measured correctly.

Scanning in the receiver mode

In the receiver mode, the R&S FSH can scan across a defined number of frequencies and graphically display the results. It performs a measurement at each frequency for the defined measurement time.

- Press the SPAN softkey.
- Press the FREQ SCAN softkey.

The R&S FSH switches to the scan mode and displays the measurement levels at the individual frequencies as vertical lines.

- Press the SCAN START softkey.
- Enter the start frequency for the scan.
- Press the SCAN STOP softkey.
- Enter the stop frequency for the scan.
- Press the SCAN STEP softkey.
- Enter the step size for the scan.

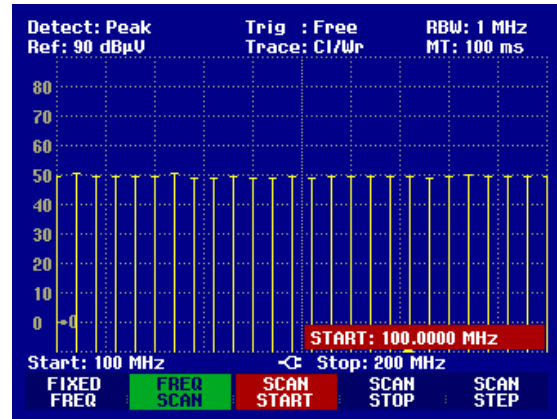

It is also possible to scan the frequencies of a channel table. This requires activating a channel table as follows:

- Press the FREQ softkey.
- Press the CHANNEL MODE softkey.

The R&S FSH now performs a measurement at the frequencies of the channel table.

Measuring the Carrier-to-Noise Power Ratio

The R&S FSH offers a carrier/noise (C/N) measurement for measuring the ratio of carrier power to noise power. The R&S FSH performs the measurement in two steps. First, it measures the carrier power of a transmission channel, or the user determines a reference power, which is then used to calculate the C/N. Second, the R&S FSH measures the noise power of an unoccupied transmission channel and calculates the ratio of carrier power to noise power.

For easy operation, device setup can be performed in accordance with a standard. The standard settings are defined by means of the supplied R&S FSH VIEW PC software in the standard editor.

Determining the carrier power (reference)

The reference is determined by measuring power/level in the reference channel.

As an alternative to the carrier power measurement, the reference can be entered manually, and it is then used in the carrier / noise calculation.

Noise power and carrier-to-noise power ratios C/N and C/N₀

For measuring the noise power, the R&S FSH is set to an unoccupied transmission channel. It measures the noise power in accordance with the noise channel bandwidth that has been set.

The R&S FSH defines the carrier-to-noise ratio by determining the ratio of the previously determined reference to the measured noise power of the unoccupied transmission channel (C/N). The R&S FSH displays the ratio logarithmically.

$$C/N = \text{reference power} - \text{noise power in the channel}$$

Alternatively, the R&S FSH displays the ratio of the reference to the noise power density (C/N₀).

$$C/N_0 = C/N + 10 \lg (\text{noise channel bandwidth/Hz})$$

Operating sequence:

- Press the MEAS key.
- Press the MEASURE softkey.

The menu for measurement functions opens.

- Using the cursor keys or the rotary knob, select CARRIER/NOISE from the menu and confirm your choice with the ENTER key or the MEASURE softkey.

The R&S FSH activates the carrier/noise mode and starts the reference measurement that was selected last.

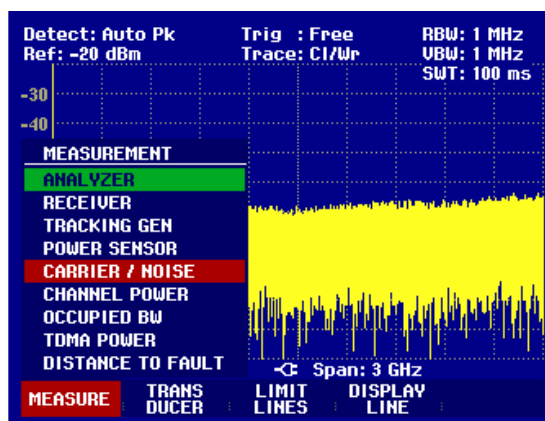

The most important measurement parameter settings are available directly in the main menu of the carrier/noise measurement or can be entered using the corresponding function keys.

Determining the Reference

Before the carrier-to-noise power ratio can be determined, the reference power or the reference level must be defined. The R&S FSH measures the reference in accordance with the standard that has been set. Alternatively, the reference can be set manually.

Standards

For easy operation, device setup can be performed in line with a standard. A standard contains the settings of the reference measurement as well as the settings of the noise power measurement.

Device setup can be performed in accordance with the USER standard or a customer-specific standard. The USER standard automatically accepts the user's settings and sets them the next time they are called. Customer-specific standards can be defined by means of the supplied R&S FSH View PC software and loaded in the R&S FSH. The factory-shipped instrument contains predefined, customer-specific standards (ANALOG TV, DIGITAL TX, and CW TX). These standards can be used as a basis, and they can be modified, renamed, or deleted by means of FSH View.

Standard parameters

A standard defines the following parameters:

Reference measurement	Noise power measurement
• Resolution bandwidth	• Resolution bandwidth
• Video bandwidth	• Video bandwidth
• Sweep time	• Sweep time
• Frequency span	• Frequency span
• Detector	• Detector
• Channel bandwidth	• Noise channel measurement bandwidth
• Frequency input mode	• C/N channel bandwidth
• Power unit	• Frequency coupling with reference channel
• Power measurement mode	• Frequency offset
	• Correction of the displayed average noise level

Operating sequence:

- Press the SELECT MEASURE softkey.
- Using the rotary knob or the cursor keys, select the desired standard and confirm your choice with the ENTER key or the SELECT MEASURE softkey.

Selecting the reference channel

- Press the REF MEASURE softkey.
- Using the rotary knob or the cursor keys, select the desired entry (Channel, Vision Carrier Freq, Center Freq, or 8VSB Pilot Freq) and confirm your choice with the ENTER key or the REF MEASURE softkey.

Alternatively, you can enter the channel center frequency after pressing the FREQ function key.

The R&S FSH displays the frequency spectrum of the reference channel symmetrical to the channel center and carries out the reference measurement.

Entering the channel bandwidth of the reference channel

- If the reference measurement is active, press the CHANNEL BW softkey.
- Enter the desired value and terminate the entry with the appropriate unit key.

The R&S FSH sets the span in accordance with the selected bandwidth.

The channel center frequency is calculated when the vision carrier frequency is entered.

Selecting the unit for the reference

- Press the LEVEL softkey.
- Using the rotary knob or the cursor keys, select the desired entry (dBm, dBmV, or dB μ V) and confirm your choice with the ENTER key or the LEVEL softkey.

The reference measurement result is displayed in the selected unit.

Manually entering the reference

- Press the REF MEASURE softkey.
- Using the rotary knob or the cursor keys, select MAN REFERENCE and confirm your choice with the ENTER key or the REF MEASURE softkey.
- Enter the desired reference value in the selected reference unit by means of the numeric keypad and terminate the entry with one of the unit keys.

Automatic level adjustment

- If the reference measurement is active, press the LEVEL softkey.
- Using the rotary knob or the cursor keys, select LEVEL ADJUST and confirm your choice with the ENTER key or the LEVEL softkey.

The R&S FSH is adjusted to the optimum level on the basis of the input signal.

Measuring the Noise Power and Calculating Carrier Power / Noise Power

The noise channel power is measured in an unoccupied transmission channel. The R&S FSH measures the spectrum within the channel using a resolution bandwidth that is small in comparison with the channel bandwidth. The results plotted on the trace are then integrated to form the total power. The R&S FSH takes into account the behavior of the selected display mode (linear or logarithmic) of the selected detector and the resolution bandwidth. The narrow resolution bandwidth acts like a steep channel filter, thus preventing out-of-channel emissions from affecting the result.

To increase the measurement dynamic range, the R&S FSH measures the displayed average noise level. When requested, the R&S FSH includes the displayed average noise level in the C/N calculation. The correction of the C/N result is limited to 6 dB.

If a complete transmission channel is not available for the measurement of the noise channel power, the measurement can also be carried out in a small unoccupied frequency band (CN NOISE CHANNEL BW). The C/N ratio is converted to the entire bandwidth of the transmission channel (CN RATIO CHANNEL BW).

To determine the C/N power ratio, the reference is set in relation to the measured noise channel power of the transmission channel.

$$\text{Carrier / Noise} = \text{Reference / Noise Channel Power}$$

Selecting the result display

The R&S FSH displays the C/N ratio referenced to the C/N noise bandwidth or referenced to a bandwidth of 1 Hz.

- Press the SELECT MEASURE softkey.
- Using the rotary knob or the cursor keys, select the desired result display (C/N or C/N0) and confirm your choice with the ENTER key or the SELECT MEASURE softkey.

The R&S FSH outputs the power ratio according to the selected result display.

Frequency setting of the noise channel

The frequency setting of the reference channel can be retained, or it can be set by entering the channel number in accordance with the selected channel/frequency table, by entering the channel center frequency, by entering the vision carrier frequency, or by entering the 8VSB/ATSC pilot frequency.

If the noise power measurement is performed in the same channel as the reference measurement (Coupled to Ref...), the RF signal of the measurement channel must be disabled for the measurement of the noise power. In the Coupled to Reference setting, a frequency offset can be entered after the selection.

- Press the NOISE MEASURE softkey.
- Using the rotary knob or the cursor keys, select COUPLED TO REFERENCE, CHANNEL, VISION CARR FREQ, 8VSB PILOT CARR FREQ, or CENTER FREQ, and confirm your choice with the ENTER key or the NOISE MEASURE softkey.

The appropriate entry box will open. You can do any of the following:

- Using the rotary knob or the cursor keys, change the frequency, the channel, or the offset.
- Using the numeric keypad, enter a new frequency, channel, or offset, and confirm your input with the ENTER key or the NOISE MEASURE softkey.

- Confirm the displayed frequency, channel, or offset with the ENTER key or the NOISE MEASURE softkey.

You can alternatively enter the channel center frequency after pressing the FREQ function key.

Note: When the channel number is entered, the R&S FSH assumes that the channel center frequency is entered in the channel table. This needs to be taken into consideration when creating channel tables.

Setting the noise channel measurement bandwidth

The noise power is measured within the noise channel measurement bandwidth.

- If the noise power measurement is active, press the CHANNEL BW softkey.
- Using the rotary knob or the cursor keys, select CN NOISE CHANNEL BW... and confirm with the ENTER key or the CHANNEL BW softkey.
- Enter the desired value and terminate the entry with the appropriate unit key.

The R&S FSH automatically adjusts the frequency span in the Auto Span setting to the entered noise channel measurement bandwidth.

Setting the C/N channel bandwidth

The C/N channel bandwidth is used to calculate the C/N ratio, i.e. the measured noise power that was determined with the set noise channel measurement bandwidth CN NOISE CHANNEL BW, and it is converted to the corresponding noise power of the C/N channel bandwidth CN RATIO CHANNEL BW in order to calculate the C/N ratio.

- If the noise channel measurement is active, press the CHANNEL BW softkey.
- Using the rotary knob or the cursor keys, select CN RATIO CHANNEL BW... and confirm with the ENTER key or the CHANNEL BW softkey.

The R&S FSH opens the entry box for the channel bandwidth (CHAN BW) with the C/N channel bandwidth just selected.

- Using the numeric keys, enter the C/N channel bandwidth and terminate your entry with the appropriate unit key, or
- Set the C/N channel bandwidth with the rotary knob or the cursor keys.

Automatic level adjustment

To simplify operation and to prevent incorrect measurements, the R&S FSH offers an automatic routine for setting the reference level.

- If the noise power measurement is active, press the LEVEL softkey.
- Using the rotary knob or the cursor keys, select LEVEL ADJUST and confirm your choice with the ENTER key or the LEVEL softkey.

The R&S FSH is adjusted to the optimum level on the basis of the input signal.

Correcting the displayed average noise level

The R&S FSH permits a correction of the C/N result by the displayed average noise level of the R&S FSH. The value of the displayed average noise level (receiver noise figure) depends on the device setup dynamic range, preamplifier, and reference level.

Note: The system noise power correction is limited to 6 dB.

- If the noise channel measurement is active, press the NOISE MEASURE softkey.
- Using the rotary knob or the cursor keys, select NOISE CORRECTION... and confirm your choice with the ENTER key or the NOISE MEASURE softkey.

Using the rotary knob or the cursor keys, select ON or OFF and confirm your choice with the ENTER key or the NOISE MEASURE softkey.

Hiding the result display

The C/N ratio or the reference is indicated at the bottom of the display. This display can be disabled.

- Press the NOISE MEASURE softkey.
- Using the rotary knob or the cursor keys, select DISPLAY OFF and confirm your choice with the ENTER key or the REF MEASURE or NOISE MEASURE softkey.

The R&S FSH hides the result display.

Note: Switching the C/N measurement result on or off also affects the display of the result of the reference measurement.

Saving and Recalling Settings and Test Results

Instrument settings and results can be saved to the R&S FSH's internal CMOS RAM. Results and settings are always stored together, allowing them to be interpreted in context when recalled. The R&S FSH can store a maximum of 100 data sets, each with a unique name.

Saving Measurement Results

- Press the SAVE / PRINT key.
- Press the SAVE softkey.

An input box opens and you will be prompted to enter a name for the data set to be saved.

The name for the most recently stored data set is suggested in the 'Name:' entry box, which is highlighted in red. When you press the ENTER key or the SAVE softkey a second time, the data set is saved under the suggested name.

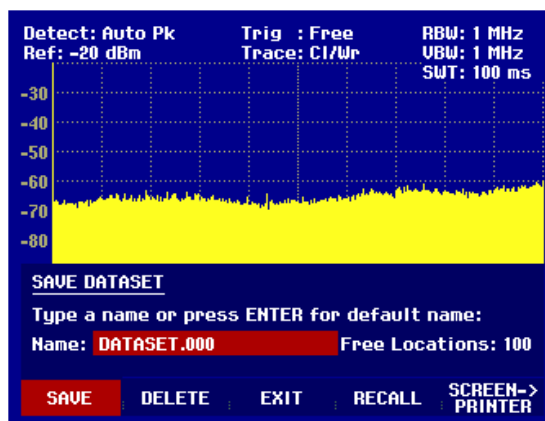

By pressing the BACK key, you can instruct the R&S FSH to browse through the list of names of the data sets already stored and display them with the first available free extension. Thus, the name of the data set recalled for a specific measurement can be selected for storing the measurement data.

A new name can be entered via the numeric keypad. The numeric keypad has the same letter assignment as mobile phone keypads. Enter the letter above the key by pressing the key the appropriate number of times.

The number of free memory locations is also displayed.

- Enter a name for the data set using the numeric keypad.
- Confirm with ENTER.

The data set is saved to the R&S FSH's internal memory under the specified name.

The name of an existing data set can be edited with the cursor keys. It is therefore not necessary to fully enter the name of a new data set.

- Press the SAVE key.

The R&S FSH suggests a name for the data set to be saved.

- Press a cursor key (^ or v).

A vertical cursor is positioned at the end of the name for the data set.



- Use the \vee key to move the cursor to the left.
- Use the \wedge key to move the cursor to the right.
- Insert a new letter or number at the cursor position using the alphanumeric keypad.
- Press the BACK key to delete the letter or digit to the left of the cursor.

Saving Calibration Data

When performing scalar transmission or return loss measurements, the R&S FSH can store the calibration data along with the settings and results. Saving the settings and results with calibration data requires twice as much memory space as without it. This, of course, reduces the maximum number of data sets that can be saved.

R&S FSH6 and model 23 of the R&S FSH3 (starting from serial number 102314) also make it possible to save the calibration data for vector transmission or vector reflection measurements.

In the default state, calibration data storage is disabled.

- Press the SETUP key.
- Press the GENERAL softkey.
- Select SAVE CAL DATA... and confirm by pressing the ENTER key or the GENERAL softkey.
- Using the rotary knob or the cursor keys, select ON or OFF.
- Confirm with ENTER.

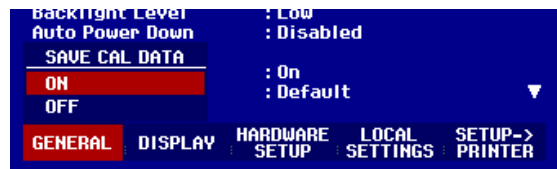

The state for calibration data saving is entered in the SETUP menu.

When recalling data sets with stored calibration data, the R&S FSH checks whether the current instrument temperature corresponds to the instrument temperature at the time the data was stored. If it deviates more than 5°C, the R&S FSH displays a red dot in front of the Transmission or Reflection display. Recalibration is then necessary.

Recalling Measurement Results

Use the R&S FSH's recall function to review previously saved measurement results and settings.

- Press the SAVE / PRINT key.
- Press the RECALL softkey.

A list of all saved data sets opens. The red selection bar marks the last data set to be saved.

- Select a data set from the list using the rotary knob. Confirm your selection by pressing the RECALL softkey.

The selected data set is displayed on the screen, but the R&S FSH is not set to the settings in the data set. You can now check the data set before its settings are activated.

The name of the selected data set is displayed at the lower left-hand corner of the screen.

Using the rotary knob or the cursor keys, you can scroll through all the available data sets. The settings and results for each data set are displayed.

02/01/1995	DATASET LIST	00:15:25
LGF12Z011.000	31/07/2002 13:58:26	
DTF RG258.001	28/02/2002 11:50:15	
DTF RG258.000	27/02/2002 21:02:12	
DTF Setup.000	26/02/2002 23:34:01	
DATASET.002	12/02/2002 18:29:36	

DELETE ALL DELETE EXIT RECALL LIST-> PRINTER

You now have the following options:

- Press the STATUS softkey to see all the instrument settings in the selected data set. When you press the STATUS key again, the R&S FSH returns to the graphical display.
- Use the rotary knob or the cursor keys to browse the stored data sets and display the respective content.
- Press the ACTIVATE softkey to load the data set.
- Press the EXIT softkey to display the list of data sets again. Press EXIT a second time and the R&S FSH returns to its previous settings without loading a data set.
- Press the SCREEN -> PRINTER softkey to send the displayed data set to a printer.

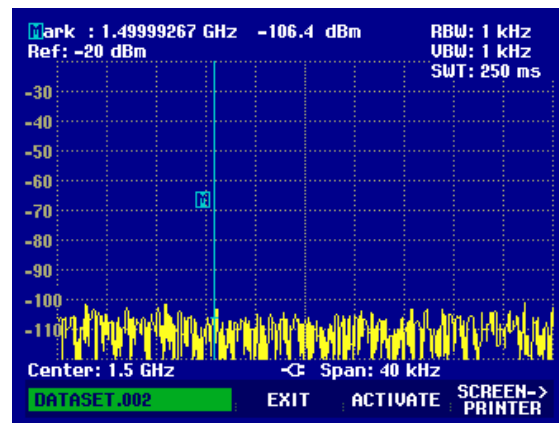

Pressing the ACTIVATE softkey transfers the stored trace to the R&S FSH's trace memory. The current trace can be compared with the stored one by switching on the trace memory.

- Press the TRACE key.
- Press the SHOW MEMORY softkey.

The R&S FSH displays the stored trace in white and the current trace in yellow.

Note.: The trace is in the R&S FSH's trace memory. The level and frequency values are displayed correctly only if neither the instrument's frequency setting nor its level setting have been changed.

Printing Out Measurement Results

The R&S FSH can send screenshots to a printer equipped with a serial interface. The type of printer and the baud rate of the serial interface can be defined in the setup menu (SETUP key) by using the GENERAL softkey and selecting 'PRINTER BAUD...' and 'PRINTER TYPE...' from the menu. For printers with a parallel interface, a serial/parallel converter (R&S FSH-Z22) is available.

Printer with serial interface

- Connect the printer to the optical interface using the RS-232-C optical cable R&S FSH-Z34.

Printer with parallel interface

- Connect the Serial/Parallel Converter R&S FSH-Z22 to the optical interface of the R&S FSH.
- Connect the R&S FSH-Z22 parallel interface to the printer.
- Switch on the Serial/Parallel Converter R&S FSH-Z22

Operating the R&S FSH

- Press the SAVE / PRINT key.

The SAVE/PRINT menu with the option for printing out a screenshot to a printer opens.

- Press the SCREEN->PRINTER softkey.

The R&S FSH starts printing out the screenshot to a printer.

